



LIANG CHEW HARDWARE

联洲五金



To Get Softcopy Book



*"Your partner in water systems
Don't install without us."*

我们是您水暖行业首选，今日选择造就明日幸福！

We offer a wide range of products for sanitary,
water irrigation and swimming pools in residential
and commercial projects.

Product Brands



Town Office

133 Kitchener Road
Singapore 208517
Tel (65) 6296 0224
Fax (65) 6296 7195 (Local)
Fax (65) 6392 1280
(International)
Email:
sales@norika.com.sg

North Office

10 Admiralty Street,
Northlink Building #02-45
Singapore 757695
Tel (65) 6555 7457
Fax (65) 6555 5710



To find more about us,
Scan here to
Liangchew.com !



Shop with us at Lazada
and Shopee!
#supportlocal



Edited: 21/05/2026

BALL VALVES

MATERIAL: BRASS



SKU: AVCRN
DZR BRASS ANGLE BALL VALVE [CHROME PLATED]
Size availability:
 $1/2" \times 3/8"$, $1/2" \times 1/2"$



SKU: MBVCRN
DZR BRASS MINI BALL VALVE Mx F [NICKEL PLATED]
Size availability:
1/4" to 1"



SKU: MBVCRN-CP
1/2" DZR BRASS MINI BALL VALVE Mx F [CHROME PLATED]



SKU: MBVCRCCN-CP
DZR BRASS MINI BALL VALVE Cx C [CHROME PLATED]
Size availability:
 $1/2"$, $3/4"$



SKU: MBVCRPFN015
1/2" DZR BRASS [PFxCC] MINI BALL VALVE [CHROME PLATED]



SKU: BVCRN-F
DZR BRASS FULL BORE BALL STOP VALVE CHROME PLATED
Size availability:
 $1/2"$ to 4"



SKU: BVLN
LOCKABLE BRASS FULL BORE BALL VALVE
Size availability:
 $1/2"$ to 2"



SKU: NJF772
DZR BRASS TWO WAY VALVE
Size availability:
1/2"



SKU: FVBR
BRASS FOOT VALVE C/W BS21 FEMALE THREADED END
Size availability:
 $1/2"$ to 4"



SKU: BVCRCCN-F
DZR BRASS COMPRESSION BALL VALVE
Size availability:
 $1-1/4"$ to $2 1/2"$



SKU: MBVCRN015TO
DZR BRASS [CXC] TEE OFF MINI BALL VALVE [NICKEL PLATED] [MXF]
Size availability:
1/2"



SKU: MBVCRN015TOPF
DZR BRASS [PFxPFxCC] TEE OFF MINI BALL VALVE [CHROME PLATED] [MXF]
Size availability:
1/2"

MATERIAL: AISI304/316



SKU: BVSS316N
LOCKABLE BLUE HANDLE AISI316 FULLBORE BALL STOP VALVE
Size availability:
 $1/4"$ to 4"



SKU: BV3PSSPFN
LOCKABLE BLUE HANDLE AISI304 PRESS-FIT BALL VALVE
Size availability:
 $1/4"$ to 4"



SKU: NJF799
AISI304 ONE TO DUAL OUT VALVE
Size availability:
1/2"



SKU: YSBVSS-MF
AISI304 Y STRAINER BALL VALVE
Size availability:
 $1/2"$ ~ $2 1/2"$

MATERIAL: DUCTILE IRON



SKU: CVDIU
DUCTILE IRON
UNI-CHECK VALVE
Size availability (inch):
2" to 12"



SKU: CVDIN
DUCTILE IRON TWIN FOLD
WAFFLE CHECK VALVE
Size availability (inch):
3" to 12"



SKU: SCVDIN
DUCTILE IRON SWING
CHECK VALVE
Size availability (inch):
3" to 20"



SKU: CVDIN-F
DUCTILE IRON DOUBLE
FLANGE CHECK VALVE
Size availability (inch):
3", 4", 6", 12"



SKU: CVDIN100FBP
4" DUCTILE IRON SPRING
LOADED BYPASS SILENT
CHECK VALVE



SKU: BCVDIN
DUCTILE IRON BALL
CHECK VALVE
Size availability (inch):
3", 4", 6"

MATERIAL: AISI316



SKU: FLVDIN
DUCTILE IRON WAFER
FLAP CHECK VALVE
Size availability (inch):
2" to 16"



SKU: CVSS316N
AISI316 SPRING LOADED
CHECK VALVE
Size availability (inch):
1 1/2" to 4"

MATERIAL: BRASS / BRONZE



SKU: CVCRN-MF
DZR BRASS CHECK
VALVE Mx F
Size availability (inch):
3/4", 1 1/4", 2", 2 1/2"



SKU: CVCRNB-MF
DZR BRASS PISTON
SPRING CHECK VALVE Mx F
Size availability (inch):
1/2" to 2"



SKU: CVCRNB
DZR BRASS PISTON
SPRING CHECK VALVE Fx F
Size availability (inch):
1/2" to 2"



SKU: CVCRCNN
DZR BRASS SPRING
CHECK VALVE Cx C
Size availability (inch):
1/2" to 2 1/2"



SKU: CVCRPFN
PRESSFIT BRASS CR SPRING
CHECK VALVE WITH
INSPECTION HOLE
Size availability:
1/2" to 2-1/2"



SKU: DCVCRN
DZR BRASS DOUBLE
CHECK VALVE [Cx C]
Size availability (inch):
1/2", 3/4"



SKU: DCVCRN015MFCP
DZR BRASS DOUBLE CHECK
VALVE Mx F [CHROME PLATED]
Size availability (inch):
1/2"



SKU: DCVCRN-MF
DZR BRASS DOUBLE
CHECK VALVE Mx F
Size availability (inch):
3/4", 1"



SKU: SCVBR
"AMICO" HORIZONTAL BRASS
SWING CHECK VALVE
Size availability (inch):
1/2" to 4"



SKU: VBN-IN15
1/2" DZR BRASS IN-
LINE ANTI-VACUUM
BREAKER



SKU: VBN15
1/2" BRONZE ANTI-
VACUUM VALVE



SKU: FAV025
1" BRASS AUTOMATIC
AIR RELEASE VALVE



SKU: DCVCRPFN015
DZR Brass Press-fit Double
Check Valve
Size availability (inch):
1/2"

DUCTILE IRON VALVE:

SLUICE VALVE:



SKU: SVDIN /SVDIN-PUB
DUCTILE IRON
SLUICE VALVE
(Clockwise to close/
Clockwise to open)
Size availability:
3" to 16"



SKU: SVDIN-15
DUCTILE IRON
SLUICE VALVE WITH
15 MM HOLE
Size availability:
3" to 6"

BUTTERFLY VALVE:



SKU: BTFVN
DUCTILE IRON
BUTTERFLY VALVE
Size availability:
2" to 12"

SOLENOID PILOT OPERATED VALVE:



SKU: SPOVN100
4" DUCTILE IRON 3 WAYS
SOLENOID PILOT
OPERATED VALVE



SKU: SPOVN100-PL
4" DUCTILE IRON 3 WAYS
SOLENOID PILOT
OPERATED IN-LINE
VALVE

BALL FLOAT VALVE



SKU: BFFVN
BALL FLOAT VALVE
[THREAD END]
Size availability:
DZR BRASS: ½" to 1½"
BRONZE: 2" to 6"



SKU: BFFVPN
DZR BRASS ANGLE
BALL FLOAT VALVE
[THREAD END]
Size availability:
½" & 1"



SKU: BFFVNRK
RUBBER SEAL KIT
FOR BALL FLOAT
VALVE
Size availability:
½" to 6"



SKU: BFFVN-316L
AISI316L BALL FLOAT
VALVE [THREAD END]
Size availability:
½" to 2", 4"



SKU: WLSN
WATER TANK LEVEL
SENSOR (AISI316L)
LENGTH: 900, 1000,
1500mm



NEW
SKU: POVDIN-F-PL
4"/6" DUCTILE IRON IN-LINE
HYDRAULICALLY
CONTROLLED PILOT
OPERATED FLOAT
VALVE



NEW
SKU: POVDIN-F
4"/6" DUCTILE IRON IN-LINE
HYDRAULICALLY
CONTROLLED PILOT
OPERATED FLOAT VALVE
(ELBOW SHAPED)

PRESSURE REDUCING VALVE



SKU: PRVCRN
PRESSURE REDUCING
VALVE C/W FEMALE
BSP THREAD
Size availability:
1/2" to 2 1/2"



SKU: PRVCRN80/100F
PRESSURE REDUCING
VALVE C/W FLANGE
END
Size availability:
3" to 6"



SKU: PRVDIN-F
PILOT OPERATED
PRESSURE REDUCING
VALVE FLANGE END
Size availability:
4" to 6"

GLOBE VALVE:



SKU: GLVDIN100
4" DUCTILE IRON
GLOBE VALVE RISING
STEM

AISI304 FLUID SOLENOID VALVE (Waterproof Grade: IP67 / IP65)



SKU: SVSSN IP67
 NORMALLY
 CLOSED
 Size availability:
 1/2" to 2"



SKU: SVSSN-NO IP67
 NORMALLY OPENED
 Size availability:
 1/2" to 2"



SKU: SVSSN-IP65ES
 THREAD END
 (ENERGY SAVING
 NORMALLY CLOSE)
 Size availability:
 1/2" to 2"



SKU: SVSSN-F IP67
 FLANGE END
 (NORMALLY
 CLOSE)
 Size availability:
 2 1/2" to 6"



SKU: SVSSN-FNO IP67
 FLANGE END
 (NORMALLY OPEN)
 Size availability:
 2 1/2" to 6"

* Note: Normally closed means when powered off.

STOP COCK:



SKU: SCFFCRN
 DZR BRASS STOP COCK
 FEMALE THREAD END
 Size availability:
 1/2" to 1"



SKU: SCCRN
 DZR BRASS STOP
 COCK [CxC]
 Size availability:
 1/2" to 1"



SKU: SCCRN
 BRONZE STOP
 COCK [CxC]
 Size availability:
 1 1/4" to 2"



SKU: SCCRN035CR
 DZR BRASS STOP
 COCK [CxC]
 Size availability:
 1/4"



SKU: SCMBLN035
 BRONZE STOP COCK
 SOLDERING END
 Size availability:
 1/4"



SKU: SCCRPFN02015S
 BRASS CR STOP COCK PFXFI
 EDN FOR WATER METER
 Size availability:
 22MM x 1/2"

GATE VALVE:



SKU: GVCRN
 DZR BRASS GATE
 VALVE THREAD END
 Size availability:
 1/2" to 4"



SKU: GVMBLN
 BRONZE GATE VALVE
 SOLDERING END
 Size availability:
 1/2" to 3"



SKU: GVCRCN
 BRONZE PN16
 GATE VALVE [CxC]
 Size availability:
 1/2" to 2"



SKU: GVCRPFN
 DZR BRASS PRESSFIT
 GATE VALVE
 Size availability:
 1/2" to 3"

STATIC THERMAL CONTROL BALANCING VALVE



SKU: TBVCRN
 BRASS BALANCING
 VALVE [THREAD ENDED]
 Size availability:
 1/2" to 2"

TAPS / MIXER / FLUSH VALVE

TAP & SHOWER STOPCOCK & TAP BOX:



SKU: LTCRN15
STAINLESS STEEL
HANDLE BRASS CR
LOCKABLE UNION TAP
WELS Rating: ✓✓✓



SKU: LTCRN15R
RED HANDLE BRASS
CR LOCKABLE
UNION TAP
WELS Rating: ✓✓✓



SKU: UTN15
BRASS CR HOSE
UNION TAP C/W
CHROME PLATED
WELS Rating: ✓✓



SKU: UTN15SS
BRASS CR HOSE
UNION TAP C/W
CHROME PLATED
WELS Rating: ✓✓✓



SKU: UTN15CP
WASHING MACHINE
BIB TAP
WELS Rating: ✓✓✓



SKU: NXL0553
LOOSE KEY
UNION TAP
WELS Rating: ✓✓✓



SKU: UTN15N
1/2" "NORIKA" HOSE
UNION TAP NOZZLE



SKU: NXL0556
CROSS HANDLE UNION
TAP C/W AERATOR
WELS Rating: ✓✓✓



SKU: NXG15A
E-ACTION WALL
UNION TAP
WELS Rating: ✓✓✓



SKU: NJF766
BRASS CHROME PLATED
LUXURY TWO WAY TAP
WELS Rating: ✓✓



SKU: NXL0554
CROSS HANDLEQUICK
TURN ACTION
SHOWER STOP COCK



SKU: NXL0554L
LEVEL HANDLEQUICK
TURN ACTION
SHOWER STOP COCK



SKU: NXL0552
CROSS HANDLE
PILLAR SINK TAP
WELS Rating: ✓✓



SKU: NXL0552L
LEVER HANDLE
PILLAR SINK TAP
WELS Rating: ✓✓



SKU: NXG0651
CROSS HANDLE
TWO WAY TAP
WELS Rating: ✓✓✓



SKU: NXG5
QUICK TURN ACTION
WALL SINK TAP
WELS Rating: ✓✓✓



SKU: NXG6L
QUICK TURN ACTION
PILLAR SINK TAP
WELS Rating: ✓✓✓



SKU: NML9
SINGLE INLET COLD
BASIN TAP
WELS Rating: ✓✓



SKU: NML8
NORMAL-CROSS
HANDLE BASIN
PILLAR TAP
WELS Rating: ✓✓✓



SKU: NML8L
SHORT HANDLE QUICK
ACTION CHROME PLATED
BASIN PILLAR TAP
WELS Rating: ✓✓✓



SKU: NXL9
SINGLE INLET COLD
LEVER SINK TAP
WELS Rating: ✓✓



SKU: NJ23
QUICK TURN ACTION
CROSSED CYLINDRICAL
SPOKE DESIGNER ANGLE
VALVE



SKU: NJ24
QUICK TURN ACTION
DESIGNER SQUARE
ANGLE VALVE



SKU: TBSS
STAINLESS STEEL
304 TAP BOX

SENSOR TAPS



SKU: STN8110AD
SENSOR BASIN
FAUCET TAP
WELS Rating: ✓✓✓



SKU: STN8113AD
SENSOR BASIN
PILLAR TAP
WELS Rating: ✓✓



SKU: STN305D
WALL MOUNTED
SENSOR TAP
WELS Rating: ✓✓



SKU: STN1110/ 1109/ 1108AD
AISI304 SENSOR BASIN
FAUCET TAP
HEIGHT: 180, 232, 330mm
WELS Rating: ✓✓

MIXER TAPS



SKU: NSFK2035D
AISI304 PULL-OUT SINK MIXER TAP WITH TOUCH SENSOR CONTROL
WELS Rating: ✓✓✓



SKU: NSFK808C
AISI304 PULL-OUT SINK MIXER TAP
WELS Rating: ✓✓



SKU: NSFK804G
AISI304 PULL-OUT SINK MIXER TAP
WELS Rating: ✓✓



SKU: NXTS001
AISI304 LEVER HANDLE PILLAR SINK TAP
WELS Rating: ✓✓✓



SKU: NYG31
WALL MOUNTED SINGLE LEVER LONG BATH MIXER
WELS Rating: ✓✓✓



SKU: NXG12
SINGLE LEVER SINK MIXER
WELS Rating: ✓✓✓



SKU: NMG38
SINGLE LEVER SINK MIXER

COMMERCIAL PRE-RINSE MIXER TAPS, HANDICAPPED TAPS & ACCESSORIES:



SKU: NCP5802A
COMMERCIAL PRE-RINSE HOT/COLD MIXER
WELS Rating: ✓✓



SKU: NCP0213
COMMERCIAL PRE-RINSE HOT/COLD MIXER
WELS Rating: ✓✓



SKU: NCP5803-9P
WALL MOUNTED COMMERCIAL PRE-RINSE HOT/COLD MIXER
WELS Rating: ✓✓



SKU: NML8XL
LEVER HANDLE BASIN PILLAR TAP FOR AMBULANT TOILET
WELS Rating: ✓✓✓



SKU: NXL0551/ NXL0551L
CROSS / LEVER HANDLE WALL SINK TAP
WELS Rating: ✓✓✓



SKU: NFBSS
F&B SWING SPOUT LENGTH: 4" to 22"

DELAY ACTION TAPS:



SKU: DATNMG901
PRESSMATIC SELF CLOSING EXPOSED SHOWER TAP
WELS Rating: ✓✓



SKU: DATNML6
DELAY ACTION BASIN FAUCET
WELS Rating: ✓✓✓



SKU: DATNML16
DELAY ACTION BASIN FAUCET
WELS Rating: ✓✓✓



SKU: DATNML901
PRESSMATIC BID TAP DELAY ACTION WATERSAVING
WELS Rating: ✓✓✓

FOOT, KNEE OPERATED VALVES & ACCESSORIES:



SKU: DATNFV
FOOT OPERATED VALVE



SKU: DATNKV
EXPOSED KNEE OPERATED VALVE



SKU: DATNG747
SPOUT FOR THE SINK



SKU: DATN744
BASIN-MOUNTED OUTLET SPOUTS



SKU: FRN2T/ FRN4
2L/4L TERMINAL FLOW REGULATOR

WATER PURIFIER FAUCET & ACCESSORIES:



SKU: NWPFO6
STAINLESS STEEL
304 WATER
PURIFIER FAUCET



SKU: MBVSSN-TO
AISI304 SHUT OFF
VALVE TEE FOR
WATER PURIFIER
1/2"x 3/8" & 1/2"x 1/4"



SKU: WFN
WATER FILTER
5", 10"



SKU: WFE
WATER FILTER
CARTRIDGE ELEMENT
5", 10"



SKU: BTN20
BOILER TAP



SKU: PIPPE
PE PIPE FOR
WATER PURIFIER
Size: 1/4", 3/8", 1/2"



SKU: PEE90
PE PUSH-FIT
EQUAL ELBOW
Size: 1/4", 3/8", 1/2"



SKU: PERE90
PE PUSH-FIT
REDUCING ELBOW
Size: 1/4"x3/8"



SKU: PEES
PE PUSH-FIT
EQUAL SOCKET
Size: 1/4"x3/8"



SKU: PERS
PE PUSH-FIT
REDUCING SOCKET
Size: 1/4"x3/8"



SKU: PEET
PE PUSH-FIT
EQUAL TEE
Size: 1/4", 3/8", 1/2"



SKU: PEMIS
PE PUSH-FIT
MI ADAPTOR
Size: 1/4"x1/4" TO
1/2"x1/2"



SKU: PEFIS
PE PUSH-FIT
FI ADAPTOR
Size: 1/4"x1/4" TO
1/2"x1/2"



SKU: PEMIE
PE PUSH-FIT
MI ELBOW
Size: 1/4", 3/8", 1/2"



SKU: PEFIE
PE PUSH-FIT
FI ELBOW
Size: 1/4", 3/8", 1/2"



SKU: PEMBV
PE PUSH-FIT MINI
BALL VALVE
Size: 1/4", 3/8", 1/2"

FLUSHING VALVE:



SKU: MFVNBC3
EXPOSED MANUAL
OPERATED URINAL
FLUSH VALVE
WELS Rating:



SKU: MFVNBC4
EXPOSED MANUAL
OPERATED
W.C FLUSH VALVE

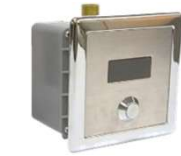

SKU: AFVN1067AD
URINAL CONCEAL
AUTO SENSOR
FLUSHING SYSTEM



SKU: AFVN3700AD
WC CONCEAL AUTO
SENSOR
FLUSHING SYSTEM

(Operated By Sensor:)

DIRECT DRINKING NOZZLE FOR ANIMALS:



SKU: ATN15-DL



SKU: ATN15-SP

SMART DRAIN FLOOR TRAP COVERS



SKU: SMARTDRAIN10040
 AISI304L DECORATIVE
 SMARTDRAIN10040 TILE &
 MARBLE
 100MMx100MMxø37MM



SKU: SMARTDRAIN10050-HDB
 AISI304L DECORATIVE
 SMARTDRAIN10050 TILE &
 MARBLE (FOR HDB Projects)
 100MMx100MMxø48MM



SKU: SMARTDRAIN12550
 AISI304L DECORATIVE
 SMARTDRAIN12550 TILE &
 MARBLE
 125MMx125MMxø50MM



SKU: SMARTDRAIN125-HDB
 AISI304L DECORATIVE
 SMARTDRAIN125 TILE &
 MARBLE
 125MMx125MMxø103MM



SKU: SMARTDRAIN125
 AISI304L DECORATIVE
 SMARTDRAIN125 TILE &
 MARBLE
 125MMx125MMxø103MM



SKU: SMARTDRAIN125T-GCB
 AISI304L LUXURY
 SMARTDRAIN TILE & MARBLE
 (For GCB Projects)
 125MMx125MMxø103MM



SKU: SMARTDRAIN150-HDB
 AISI304L DECORATIVE
 SMARTDRAIN150 TILE &
 MARBLE
 150MMx150MMxø103MM



SKU: SMARTDRAIN150
 AISI304L DECORATIVE
 SMARTDRAIN150 TILE &
 MARBLE
 150MMx150MMxø102MM



SKU: SMARTDRAIN-U150
 AISI304L DECORATIVE
 SMARTDRAIN URINAL
 TRAP COVER
 150MMx150MM



SKU: SMARTL
 AISI304L OR AISI316L LINEAR
 SHOWER DRAIN FOR TILE OR
 MARBLE

*** Customisation options are available**



SKU: LGSS316L-
 AISI316L LINEAR GRATING GCB

*** Customisation options are available**

FLOOR TRAP COVERS



SKU: 213MTN/213MTNB-
 213 UPVC ANTIMOSQUITO/
 INSECT TRAP DEVICE WITH
 FILTER: 2" & 4"



SKU:SSCGN150HLS
 6"X6" S/STEEL CAST ON
 GRATING C/W HAIRLINE
 FINISHING



SKU:SSCGN150NHLS
 6"X6" S/STEEL CAST ON
 GRATING C/W HAIRLINE
 FINISHING [NO HOLE]



SKU:SSCGN150HLSHD
 6"X6" S/STEEL CAST ON
 GRATING C/W HAIRLINE
 FINISHING [HEAVY DUTY]



SKU:SSCGN150NHLSHD
 6"X6" S/STEEL CAST ON
 GRATING C/W HAIRLINE
 FINISHING [HEAVY DUTY]
 NO HOLE



SKU: SSGNHL-R3P
 S/STEEL SS304 SQUARE
 GRATING C/W 3 PIN
 ROUND COVER
 4"x4" & 6"x6"



SKU: SSGNHLNH-R3P
 S/STEEL SS304 SQUARE
 GRATING C/W 3 PIN
 ROUND COVER [NO HOLE]
 4"x4" & 6"x6"



SKU: SSGN-HLJ
 S/STEEL GRATING C/W
 HAIRLINE FINISHING JAPAN
 STYLE /HEAVY DUTY
 Size availability:
 4"x4", 6"x6"



SKU:SSGN-HL
 S/STEEL 304/316 GRATING
 C/W HAIRLINE FINISHING
 Size availability:
 4"X4" & 6"X6"



SKU: SSGN150HLWL
 6" S/STEEL GRATING
 C/W HAIRLINE
 FINISHING [WITH LOCK]
 / HEAVY DUTY



SKU:SSGN-HLA
S/STEEL GRATING C/W
HAIRLINE FINISHING
[ANGLE]
Size availability:
4"X4", 6"x6"



SKU:SSGN-HLNH
S/STEEL 304/316 GRATING C/W
HAIRLINE FINISHING [NO HOLE]
Size availability:
4"X4" & 6"X6"



SKU:SSGN150HLNHHL
6" S/STEEL GRATING C/W
HAIRLINE FINISHING [NO
HOLE WITH LOCK] /
HEAVY DUTY



SKU:SSUGN-HL
S/STEEL 304/316
URINAL SQUARE GRATING
C/W HAIRLINE FINISHING
Size availability:
6"X6" & 8"X8"



SKU:213G150
213 GRATING
6"X6"

ROOF DRAIN GRATINGS & FLOOR WASTE



SKU:SSCRGN-HL
S/STEEL CASTING
ROUND FLOOR GRATING
Size availability:
4"X3", 6"X4"



SKU:SSCRGN-NHHL316
S/STEEL CASTING
ROUND FLOOR
GRATING [NO HOLE]
Size availability:
3"X2"



SKU:SSDGN080HL
80MM S/STEEL DOME
GRATING C/W HAIRLINE
FINISHING ROUND SHAPE



SKU:SSDGN080HLA
80MM S/STEEL DOME
GRATING C/W HAIRLINE
FINISHING ALMOND
SHAPE



SKU:SSDGN080HLEB
80MM S/STEEL DOME
GRATING C/W HAIRLINE
FINISHING



SKU:SSRGN-HL
S/STEEL ROUND GRATING
C/W HAIRLINE FINISHING
Size availability:
80MM , 115MM



SKU:SSRGN080HLJ
3" STAINLESS STEEL
JAPANESE DESIGN
ROUND GRATING



SKU:DICPGN150
6"x6" DUCTILE IRON
CAR PARK GRATING



SKU:DIRG
DUCTILE IRON
ROUND GRATING
Size availability:
4", 6"



SKU:BRGN-HL
BRASS ROUND FLOOR
GRATING
Size availability:
3"X2", 4"X3", 6"X4"



SKU:BRGN-HLCP
BRASS ROUND GRATING
C/W HAIRLINE FINISHING
CHROME PLATED
Size availability:
4"X3", 6"X4"



SKU:BGN150SRNHHL
BRASS SQUARE
FLOOR GRATING
[NO HOLE]
Size availability:
6"X6"



SKU:BGN150SRNHHLCP
BRASS GRATING C/W
HAIRLINE FINISHING
CHROME PLATED [NO HOLE]
Size availability:
6"X6"



SKU:213RG
ROUND GRATING
3" , 4"

norika® **BATHROOM ACCESSORIES**

SOAP & PAPER DISPENSER:



SKU: SDN
S/STEEL SOAP
DISH



SKU: SDNH
HORIZONTAL AISI304
LIQUID SOAP
DISPENSER
1200ML



SKU: SDNV
VERTICAL AISI304
LIQUID SOAP
DISPENSER
1000ML



SKU: SDN610D
AIS304 AUTOMATIC
SOAP DISPENSER
650ML



SKU: JRDN/ JRSDN/ SSPHN
JUMBO ROLL DISPENSER
PAPER HOLDER

AISI304 & ANTIBACTERIAL GRAB BAR: (Size could be customized)



SKU: SSGB
S/STEEL GRAB BAR
250MM TO 900MM



SKU: SSGBL7001200
S/STEEL GRAB BAR
700MMx1200MM



SKU: SSUGB800300
S/STEEL GRAB BAR
800MMx300MM



SKU: SSGBV700700
S/STEEL GRAB BAR
700MMx700MM



SKU: ABGB
ANTI-BACTERIAL NYLON
GRAB BAR
250MM TO 900MM



SKU: ABGBL07001200
ANTI-BACTERIAL NYLON
GRAB BAR
700MMx1200MM



SKU: ABUGB750200
ANTI-BACTERIAL NYLON
GRAB BAR
750MMx200MM



SKU: ABGBV700700
ANTI-BACTERIAL NYLON
GRAB BAR
700MMx700MM

HAND DRYER:



SKU: HDN165A
AUTOMATIC
HAND DRYER



NEW

SKU: HDN2822
SENSOR OPERATED
HIGH SPEED HAND
DRYER



SKU: HDN1882
AUTOMATIC QUICK DRY
HAND DRYER

PAN COLLAR:



SKU: 213PC100
SS213 PAN
COLLAR 4"



SKU: 213PC10025
SS213 PAN
COLLAR 4"x1"



SKU: 213PC10050
SS213 PAN
COLLAR 4"x2"



SKU: 213PC10080
SS213 PAN
COLLAR 4"x3"



SKU: 213PC100UK
4" UPVC SOFT
PAN COLLAR



SKU: 213PC10025UK
4"x1" W.C OFFSET
SOFT PAN COLLAR

WC ACCESSORIES:



SKU: 213PC100WC
4"x90 UPVC WC WIRE
CONNECTOR



SKU: 213PC100B
4"x90x180MM W.C
BEND CONNECTOR



SKU: DSWWHD/ DSWW
WC SEAT COVER
HEAVY DUTY &
LIGHT DUTY



SKU: DSWWAK
ADULT TOILET SEAT
WITH CHILD POTTY
TRAINING COVER



SKU: DSWWWL
MANUAL CONTROL SMART TOILET
SEAT WITH DUAL WASHLET
BIDET/HYGIENIC SPRAY



SKU: TOTH633
TOTH633 - WC
TOTH633-1 - URINAL



SKU: AAVN
2" AIR ADMITTANCE
VALVE



SKU: GIWHWCB
GALVANISED IRON WALL
HUNG WC BRACKET



SKU: DSBSS
WC SEAT
COVER BRACKET



SKU: WCS8RD60
BRASS SCREW FOR
WALL MOUNT WC

WC BALL FLOAT:



SKU: BFNHJ1226
3/8", 1/2" PLASTIC FLOAT
VALVE , C/W SIDE OR
PEDESTAL INLET



SKU: BFN15BI
1/2" BOTTOM INLET
PLASTIC FLOAT VALVE



SKU: BFNHJ1207
1/2" PLASTIC FLOAT
VALVE ,SIDE INLET



SKU: BFNHJ1209
1/2" PLASTIC COMPACT
FLOAT VALVE C/W
BALL ,SIDE INLET

WC SYPHON:



SKU: SYPNHP09A
2" DUAL FLUSH SYPHON
+ PUSH BUTTON C/W
2 " BASE OUTLET



SKU: SYPNHP10A
2" TOP PRESS DUAL
FLUSH WITH BASE
OUTLET 50MM

BIDET SPRAY SET:



SKU: BSNW
PLASTIC BIDET
SPRAY SET



SKU: BSNCP
BRASS CHROME
BIDET SPRAY SET



SKU: BSNSS
STAINLESS STEEL
BIDET SPRAY SET

SHOWER ROSE:



SKU: SRN50
BRASS CHROME
OVERHEAD RAIN
SHOWER ROSE
50MM



SKU: SRN100
4" SHOWER ROSE



SKU: SRN150/200/250
PLASTIC CHROME
OVERHEAD RAIN
SHOWER ROSE 150MM/
200MM/ 250MM



SKU: SRN250-9214
SHOWER ROSE
250MM



SKU: SY860C
BRASS CHROME
OVERHEAD STAR DESIGN
SHOWER ROSE 200MM



SKU: SY315C
BRASS CHROME
SHOWER ROSE



SKU: SY-707
LUXURY SPRINKLER
LIFTER SHOWER SET



SKU: SY689C
PLASTIC CHROME
HAND SHOWER



SKU: SY9573
HANDSHOWER PLASTIC
CHROME PLATED



SKU: SYA82
BRASS CHROME SHOWER
ARM 1/2"X400MM



SKU: SY303C
CHROME WALL
MOUNTED SHOWER
HEAD HOLDER

FLEXIBLE TUBE/ HOSE & ACCESSORIES:



SKU: FTN15
STAINLESS STEEL
FLEXIBLE TUBE
LENGTH:
150MM TO 2100MM



SKU: FTNM1015500
S/STEEL HOT/COLD
FLEXIBLE TUBE
M10 X 1/2" MIXER
COPPER TUBE



SKU: BSN1200
S/STEEL FLEXIBLE
HOSE C/W JET
NOZZLE
1/2"X1200MM



SKU: SHN
S/STEEL / PVC
FLEXIBLE HOSE
Size availability:
1.2M,1.5M,1.8M



SKU: MFEL
MIXER FLANGE
ELBOW
WITH LOCK



SKU: MFE
MIXER FLANGE
ELBOW

WASTE & PLUG :



SKU:WP35SS304
AISI304 WASTE
PLUG & CHAIN
1 1/4"



SKU:WP42
BRASS WASTE
PLUG & CHAIN
1 1/2"



SKU:WP312
BASKET SINK S/STEEL
WASTE STRAINER
LOCKABLE



SKU: WP312F
BIG BASKET
WASTE OD: 119x
H:116x G:11/2"



SKU: WP412F
BIG BASKET
WASTE OD: 145x
H:116x G:11/2"



SKU: WP612F
BIG BASKET
WASTE OD:144x
H:113x G:11/2"



SKU: WPLBPU
1 1/2" LONG BATH POP-
UP WASTE & PLUG

OVERFLOW:



SKU: NMP6/NMP6A
BASIN PUSH DOWN
WASTE C/W
OVERFLOW & NUT

WASHIN MACHINE HOSE:



SKU: WMI2M
1/2"X2MM WASHING
INLET HOSE



SKU: WMO2M
2M WASHING MACHINE
OUTLET PIPE

BOTTLE TRAP:



SKU: 213BT
UPVC BOTTLE TRAP
35MM, 35x42MM, 42MM



SKU:BTCP35
1 1/4" CHROME PLATED
BOTTLE TRAP



SKU:BTSS35
1 1/4" AISI304
BOTTLE TRAP



SKU:RBBT
RUBBER BUSH FOR
1 1/2" SS213 ELBOW TO
1 1/4" CP BOTTLE TRAP //
1 1/2" SS213 ELBOW TO
1 1/2" CP BOTTLE TRAP

ACCESSORIES:



SKU: CCE32CP
CHROME PALTED
[CXC] ELBOW
FOR S/STEEL
FLUSH PIPE



SKU: CCU32CP
CHROME PALTED
[CXC] SOCKET FOR
S/STEEL FLUSH PIPE



SKU:SSFP
S/STEEL FLUSH PIPE
1000X400 & 700X300



SKU:RBWC
RUBBER BUSH FOR
WC S/STEEL & PVC
FLUSH PIPE



SKU:SSFP32
1 1/8"X12" BRASS
CP SHORT PIPE



SKU:SAB / BAB
GALVANISED IRON
SINK ANGLE BRACKET &
BASIN ANGLE BRACKET
Size availability:
425MMX148MMX90°
268MMX134MMX90°



SKU: WHBR
WATER HEATER BRACKET
FOR "RHEEM"
Size availability:
6 TO 30 GALLON



SKU: PB
PORTMAN BRACKET
FOR BASIN



SKU: SSWM30MESH
AISI304 WIRE 30MESH,
1Mx30M Ø.0.25MMx30MESH
MESH SIZE: 0.60MM

DZR BRASS:



SKU: CRRN
DZR BRASS
REDUCING NIPPLE
Size: 15x6, 15x10,
22x15, 54x42mm



SKU: CREN
DZR BRASS NIPPLE [MxM]
Size availability:
1/2" to 4"



**SKU: CRES015/
CRES015L**
DZR BRASS SOCKET
Size: 1/2" x33mm, 1/2"x45mm



SKU:CRRB
DZR BRASS BUSH
Size availability:
15X8mm to 65x50mm



SKU:CRSP
DZR BRASS SCREW
PLUG
Size: 1/2" to 2"



SKU: CRA
DZR BRASS
FLXMI ADAPTOR
Size: 1/4", 1/2"x3/8",
3/4"x1/2"



SKU: PGN15
1/2"X80MM [MIXFI]
1/2"X60,100,200,
400MM [MIXMI]



SKU: PGN15080MFCP
1/2" BRASS PROLONGATED
NIPPLE C/W
[CHROME PLATED]



SKU: PGN-MF
PROLONGATED NIPPLE
1/2"X25,35,45,55,65,75,80,
100MM, 3/4"X25MM [MIXFI]



SKU:CRRB02015ICP
DZR BRASS BUSH
Size: 3/4"x 1/2"

AISI304 STRAINER (Size could be customized):



SKU: SSFTFN
AISI304 FLOOR TRAP
STRAINER FOR FOOD
COURT [INTERNAL
FILTER]



SKU: SSSPFN-R
S/STEEL FLOOR TRAP
STRAINER FOR FOOD
COURT [INTERNAL
FILTER] C/W ROUND
COLLAR



SKU: SSFTFN80NC
S/STEEL FLOOR TRAP
STRAINER FOR FOOD COURT
[INTERNAL FILTER] W/O
ROUND COLLAR



SKU: SSSPFN-R12
S/STEEL FLOOR TRAP
STRAINER FOR FOOD
COURT [INTERNAL FILTER]
12MM HOLE C/W ROUND
COLLAR



SKU: SSFTFN-12
S/STEEL FLOOR TRAP
STRAINER FOR FOOD
COURT [OUTER FILTER]
12MM HOLE



SKU: SSFTFN80NC12
S/STEEL FLOOR TRAP
STRAINER FOR FOOD COURT
[INTERNAL FILTER] 12MM
HOLE W/O ROUND COLLAR

“AMICO” TAP



SKU: AMCXG31
SINGLE LEVER
SINK MIXER



SKU: AMCMG2
SINGLE LEVER
BASIN MIXER

KEMBLA COPPER PIPE



COUNTRY OF ORIGINAL:AUSTRALIA
WORKING PRESSURE:MAX 10 BARS
STANDARD:BSEN1057

SIZE	X THICKNESS	Y THICKNESS	SIZE	X THICKNESS	Y THICKNESS
15MM	0.7MM	1.0MM	50MM	1.2MM	2.0MM
22MM	0.9MM	1.2MM	67MM	1.2MM	2.0MM
28MM	0.9MM	1.2MM	76MM	1.5MM	2.0MM
35MM	1.2MM	1.5MM	108MM	1.5MM	2.5MM
42MM	1.2MM	1.5MM	159MM	2.0MM	3.0MM



MEDICAL GAS TUBE TO BSEN13348
COUNTRY OF ORIGINAL:AUSTRALIA

SKU	OD (MM)	THICKNESS (MM)	WEIGHT /LENGTH (Kg/5.8m)	SKU	OD (MM)	THICKNESS (MM)	WEIGHT /LENGTH (Kg/5.8m)
PIPCMG015K	15.0	0.7	1.63	PIPCMG042K	42.0	1.2	7.98
PIPCMG020K	22.0	0.9	3.09	PIPCMG050K	54.0	1.2	10.33
PIPCMG025K	28.0	0.9	3.98	PIPCMG065K	66.7	1.2	12.81
PIPCMG035K	35.0	1.2	6.61	PIPCMG080K	76.0	1.5	18.24

norika® CAPILLARY & BRASS FITTING

STANDARD:BSEN1254-1



SKU: MBL45
45 DEGREE MBL ELBOW
Size availability:
1/2" to 6"



SKU:MBLE90
MBL 90 DEGREE ELBOW
Size availability:
1/2" to 6"



SKU:MBLRE90
MBL 90 DEGREE ELBOW
Size availability:
3/4"x 1/2" to 1"x 3/4"



SKU: MBLES
MBL EQUAL SOCKET
Size availability:
1/2" to 6"



SKU:MBLEC
MBL END CAP
Size availability:
1/2" to 6"



SKU:MBLET
MBL EQUAL TEE
Size availability:
1/2" to 6"



SKU: MBLFR
MBL FITTING REDUCER
Size availability:
3/4"x1/2" TO 3"x21/2"



SKU: MBLRS
MBL REDUCER
Size availability:
1/2"x3/8" to 6"x4"



SKU: MBLFLS
MBL FLANGE SOCKET
Size availability:
1/2" to 6"



SKU: MBLRT
MBL REDUCER TEE
Size availability:
3/4"x1/2"to 6"x4"



SKU: SR0
0% SILVER ROD



SKU: MBLMIE
MBL MI ELBOW
Size availability:
15x1/2", 22x 1/2", 28x1/2", 35x1/2"



SKU:MBLFIE
MBL FI ELBOW
Size availability:
1/2", 3/4",1"



SKU: MBLMIA
MBL MI ADAPTOR
Size availability:
1/2" to 4"



SKU:MBLFIA
MBL FI ADAPTOR
Size availability:
1/2" to 2 1/2"

norika® **COPPER PRESSFIT / COMPRESSION FITTING**
(STANDARD: BSEN1254-2:1998)

PRESSFIT FITTINGS MATERIAL: COPPER



SKU: PFNE45-45 DEG ELBOW
Size availability:
1/2" to 3"



SKU: PFNE45-MF 45DEG ELBOW Mx F
Size availability:
1/2" to 3"



SKU: PFNE90-90 DEG ELBOW
Size availability:
1/2" to 3"



SKU: PFNE90-MF 90 DEG ELBOW Mx F
Size availability:
1/2" to 3"



SKU: PFNRE90-90 DEG REDUCING ELBOW
Size availability:
3/4"X1/2", 1"X1/2"



SKU: PFNEC END CAP
Size availability:
1/2" to 2 1/2"



SKU: PFNES EQUAL SOCKET
Size availability:
1/2" to 3"



SKU: PFNESL EQUAL LONG SOCKET
Size availability:
1/2" to 2 1/2"



SKU: PFNRS REDUCING SOCKET
Size availability:
3/4"X1/2" to 2 1/2"X 2"



SKU: PFNRS-MF REDUCER Mx F
Size availability:
3/4"X1/2" to 3"X2 1/2"



SKU: PFNET EQUAL TEE
Size availability:
1/2" to 3"



SKU: PFNRT REDUCING TEE
Size availability:
3/4"X1/2" to 3"X 2 1/2"



SKU: PFNRT0201520 REDUCING TEE
Size availability:
3/4"X 3/4"X1/2"



SKU: PFNRT0201515 REDUCING TEE
Size availability:
3/4"X1/2" X1/2"



SKU: PFNRT0151520 REDUCING TEE
Size availability:
1/2"X 3/4"X1/2"



SKU: PFNCO CROSS OVER
Size availability:
1/2", 3/4"



SKU: CPSSN AISI304 COPPER PIPE SUPPORT SLEEVE FOR PRESS FIT CLIMPING
1" to 4"

PRESSFIT FITTINGS MATERIAL: DZR BRASS



SKU: PFNMIA DZR BRASS PRESSFIT [MI] ADAPTOR
Size availability:
1/2" to 3"



SKU: PFNFIA DZR BRASS PRESSFIT [FI] ADAPTOR
Size availability:
1/2" to 2 1/2"



SKU: PFNFIE15/ PFNFIE15L DZR BRASS PRESSFIT FI ELBOW
Size availability:
1/2"



SKU: PFNMIE015 DZR BRASS PRESSFIT MI ELBOW
Size availability:
1/2"



SKU: PFNFE015 DZR BRASS FI WALLPLATE ELBOW
Size availability:
1/2"

COMPRESSION FITTINGS MATERIAL: DZR BRASS



SKU: CRCCU/ CRCCU-CP COUPLER [Cx C]
Size availability:
1/2" to 2"



SKU: CRCFIU/ CRCFIU-CP Cx FI COUPLER
Size availability:
1/2" to 2"



SKU: CRCMIU/ CRCMIU-CP Cx MI COUPLER
Size availability:
1/2" to 2"



SKU: CRCFIE/ CRCFIE-CP Cx FI ELBOW
Size availability:
1/2" to 2"



SKU: CRCCE/ CRCCE-CP ELBOW [Cx C]
Size availability:
1/2" to 2"

norika® **COMPRESSION FITTING / BRASS FITTING**
(STANDARD: BSEN1254-2:1998)



SKU: CRCMIT/ CRCMIT-CP
CXC XMI TEE
Size availability:
1/2", 1", 1 1/2"



SKU: CRCFIT/ CRCFIT-CP
CXC XFI TEE
Size availability:
1/2", 42x42x1/2"



SKU: CRCCT/ CRCCT-CP
REDUCING TEE [CxC]
Size availability:
1/2" X 1/2" X 3/4" to 2" X 2" X 1"



SKU: CRCMIU
CXMI COUPLER
Size availability:
15MM X 3/4" to 22MM X 1/2"



SKU: CRCFIU02015
CXFI COUPLER
Size availability:
22MM X 1/2"



SKU: CRCCU/ CRCCU-CP
CXC REDUCING COUPLER
Size availability:
15X12MM to 28X22MM



SKU: CRCCE/ CRCCE-CP
CXC REDUCING ELBOW
Size availability:
15X10MM, 22X15MM,
28X15MM, 35X28MM



SKU: CRCMIE/ CRCMIE-CP
CxMI ELBOW
Size availability:
1/2" to 2"



SKU: CRSE
STOP END
Size availability:
1/2" TO 2"



SKU: CRCMICT015/
CRCMICT015CP
CXMIX TEE
Size availability:
1/2"



SKU: CRCFICT015/
CRCFICT015CP
CXC FIX TEE
Size availability:
1/2"



SKU: CRCCT/ CRCCT-CP
TEE [CxC]
Size availability:
1/2" to 2"



SKU: CRSF025
DZR BRASS SWIVEL
FERRULE
Size availability:
1"



SKU:
CRFE015/CRFE015CP
CXFI WALLPLATE ELBOW
15MM X 1/2"



SKU:
CRFT015/ CRFT015CP
CXFI WALLPLATE TEE
Size availability:
1/2"



SKU: CRCR
COMPRESSION RING
Size availability:
10MM to 108MM



SKU: PPRQFNRS
COMPRESSION COUPLER
(PPR-COPPER QUICK FIT
BRASS CR EQUAL SOCKET)
Size: 20x15MM, 20x22MM, 25x22MM

norika® **STRAINER**



SKU: YSDIN
DUCTILE IRON FLANGE
END PN16 Y STRAINER
3" to 12"



SKU: YSCRN
BRASS CR Y PATTERN
STRAINER FEMALE BSP
THREAD PN16
1/2" to 2 1/2"



SKU: YSCRPFN
BRASS CR PRESS FIT
Y PATTERN STRAINER
PN16
1/2" to 2 1/2"



SKU: PGIN-GL
STAINLESS S/STEEL 304
GREASE INTERCEPTOR
Size availability (GALLON):
10 / 25 / 50



SKU: GIMSFS
"NORIKA®" GI MILD STEEL
FLOOR SUMP



COUNTRY OF ORIGINAL: CHINA
WORKING PRESSURE: MAX 25 BARS

SKU	DN	THK	LENGTH	SKU	DN	THK	LENGTH
PIPSS015N	15MM	0.6MM	5800MM	PIPSS015N-2.9M	15MM	0.6MM	2900MM
PIPSS020N	22MM	0.7MM	5800MM	PIPSS020N-2.9M	22MM	0.7MM	2900MM
PIPSS025N	28MM	0.8MM	5800MM	PIPSS025N-2.9M	28MM	0.8MM	2900MM
PIPSS035N	35MM	1.0MM	5800MM	PIPSS035N-2.9M	35MM	1.0MM	2900MM
PIPSS042N	42MM	1.1MM	5800MM	PIPSS042N-2.9M	42MM	1.1MM	2900MM
PIPSS050N	50MM	1.2MM	5800MM	PIPSS050N-2.9M	50MM	1.2MM	2900MM
PIPSS065N	67MM	1.2MM	5800MM	PIPSS065N-2.9M	67MM	1.2MM	2900MM
PIPSS080N	76MM	1.5MM	5800MM	PIPSS080N-2.9M	76MM	1.5MM	2900MM
PIPSS100N	108MM	1.5MM	5800MM	PIPSS100N-2.9M	108MM	1.5MM	2900MM



SKU: SSPFNES
EQUAL SOCKET
Size availability:
1/2" to 4"



SKU: SSPFNES-L
EQUAL LONG SOCKET
Size availability:
1/2" to 4"



SKU: SSPFNRS-MF
REDUCER MXF
Size availability:
3/4"X1/2" to 4"X3"



SKU: SSPFNRS
REDUCER
Size availability:
3/4"X1/2" to 4"X3"



SKU: SSPFNEC
END CAP
Size availability:
1/2" to 4"



SKU: SSPFNE90-MF
90DEG ELBOW MXF
Size availability:
1/2" to 4"



SKU: SSPFNE90-
90DEG ELBOW
Size availability:
1/2" to 4"



SKU: SSPFNE45-MF
45DEG ELBOW MXF
Size availability:
1/2" to 4"



SKU: SSPFNE45-
45DEG ELBOW
Size availability:
1/2" to 4"



SKU: SSPFNRE90-
90DEG REDUCING ELBOW
Size availability:
3/4"X1/2" to 2 1/2"X 1 1/4"



SKU: SSPFNFI
90DEG FI ELBOW
Size availability:
1/2" to 2 1/2"



SKU: SSPFNMI
90DEG MI ELBOW
Size availability:
3/4"X1/2" to 54X2"



SKU: SSPFNET
EQUAL TEE
Size availability:
1/2" to 4"



SKU: SSPFNRT
REDUCING TEE
Size availability:
3/4"X1/2" to 4"X3"



SKU: SSPFNFI
FI TEE
Size availability:
1/2" to 67x67x1 1/2"



SKU: SSPFNMI
MI TEE
Size availability:
1/2" to 54x54x2"



SKU: SSPFNFI
FI ADAPTOR
Size availability:
15X1/2" to 54X2"



SKU: SSPFNMI
MI ADAPTOR
Size availability:
15X1/2" to 108X4"



SKU: SSPFNMI
[MI] PIPE
Size availability:
1/2" to 2"



SKU: SSPFNFE015
WALLPLATE FI ELBOW



SKU:
SSPFNCT353525MI15FI
1 1/4"X1 1/4"X1"MI1/2"FI
PRESSFIT CROSS TEE



SKU: SSPFNMI
MALE JOINT
CONNECTOR
Size availability:
15X1/2" to 108X4"



SKU: SSPFNFI
FEMALE JOINT
CONNECTOR
Size availability:
15X1/2" to 54X2"



SKU: SSPFNFI
PRESSFIT FLANGE
SOCKET
Size availability:
1 1/4" to 4"



SKU: SSPFNFI
FLANGE SOCKET
Size availability:
1 1/2" to 4"



SKU: SSPFNFI
WALLPLATE FI TEE
15MM x15MM x 1/2"



SKU: SSPFNFI
PRESSFIT FLANGE
REDUCE SOCKET
3"x2" to 6"x4"



SKU: SSPFNFI
PRESSFIT CROSS OVER
15MM, 22MM, 28MM

* Customisation options are available



SKU: SS304NM05015MX- /
SS304NM05015FX-
PRESSFIT SINGLE SIDED
MANIFOLDS
2" PIPE X n NOS 1/2" [MI] OR [FI]



SKU: SSPFNFI
PRESSFIT WALL PLATE
DOUBLE ELBOW
15X 1/2" [FI]



COUNTRY OF ORIGINAL: CHINA
WORKING PRESSURE: MAX 25 BARS

SKU	DN	THK	LENGTH	SKU	DN	THK	LENGTH
PIPSS316L015N	15MM	0.6MM	5800MM	PIPSS316L015N-2.9M	15MM	0.6MM	2900MM
PIPSS316L020N	22MM	0.7MM	5800MM	PIPSS316L020N-2.9M	22MM	0.7MM	2900MM
PIPSS316L025N	28MM	0.8MM	5800MM	PIPSS316L025N-2.9M	28MM	0.8MM	2900MM
PIPSS316L035N	35MM	1.0MM	5800MM	PIPSS316L035N-2.9M	35MM	1.0MM	2900MM
PIPSS316L042N	42MM	1.1MM	5800MM	PIPSS316L042N-2.9M	42MM	1.1MM	2900MM
PIPSS316L050N	50MM	1.2MM	5800MM	PIPSS316L050N-2.9M	50MM	1.2MM	2900MM
PIPSS316L065N	67MM	1.2MM	5800MM	PIPSS316L065N-2.9M	67MM	1.2MM	2900MM
PIPSS316L080N	76MM	1.5MM	5800MM	PIPSS316L080N-2.9M	76MM	1.5MM	2900MM
PIPSS316L100N	108MM	1.5MM	5800MM	PIPSS316L100N-2.9M	108MM	1.5MM	2900MM



SKU: SS316LPFNES
EQUAL SOCKET
Size availability:
1/2" to 4"



SKU: SS316LPFNES-L
EQUAL LONG SOCKET
Size availability:
1/2" to 4"



SKU: SS316LPFNRS-MF
REDUCER MXF
Size availability:
3/4"X1/2" to 4"X3"



SKU:
SS316LPFNRS
REDUCER
Size availability:
3/4"X1/2" to 4"X3"



SKU: SS316LPFNEC
END CAP
Size availability:
1/2" to 4"



SKU:
SS316LPFNE90-MF
90DEG ELBOW MXF
Size availability:
1/2" to 4"



SKU:
SS316LPFNE90-
90DEG ELBOW
Size availability:
1/2" to 4"



SKU:
SS316LPFNE45-MF
45DEG ELBOW MXF
Size availability:
1/2" to 4"



SKU:
SS316LPFNE45-
45DEG ELBOW
Size availability:
1/2" to 4"



SKU:
SS316LPFNRE90-
90DEG REDUCING ELBOW
Size availability:
3/4"X1/2" to 2 1/2"X 1/4"



SKU:
SS316LPFNFI
90DEG FI ELBOW
Size availability:
1/2" to 2 1/2"



SKU:
SS316LPFNMI
90DEG MI ELBOW
Size availability:
3/4"X1/2" to 54X2"



SKU: SS316LPFNET
EQUAL TEE
Size availability:
1/2" to 4"



SKU: SS316LPFNRT
REDUCING TEE
Size availability:
3/4"X1/2" to 4"X3"



SKU: SS316LPFNFI
FI TEE
Size availability:
1/2" to 67x67x1/2"



SKU: SS316LPFNMI
MI TEE
Size availability:
1/2" to 54x54x2"



SKU: SS316LPFNFI
FI ADAPTOR
Size availability:
15X1/2" to 54X2"



SKU:
SS316LPFNMI
MI ADAPTOR
Size availability:
15X1/2" to 108X4"



SKU: SS316LPFNMI
[MI] PIPE
Size availability:
1/2" to 2"



SKU:
SS316LPFNFE015
WALLPLATE FI ELBOW



SKU:
SS316LPFNCT353525MI15FI
1 1/4"X1 1/4"X1 1/2"FI
PRESSFIT CROSS TEE



SKU: SS316LPFNMC
MALE JOINT
CONNECTOR
Size availability:
15X1/2" to 108X4"



SKU: SS316LPFNFC
FEMALE JOINT
CONNECTOR
Size availability:
15X1/2" to 54X2"



SKU: SS316LPFNFLS
PRESSFIT FLANGE
SOCKET
Size availability:
1 1/4" to 4"



SKU: SS316LPFNFP
FLANGE SOCKET
Size availability:
1 1/2" to 4"



SKU: SSPFNFT015
WALLPLATE FI TEE
15MM x 15MM x 1/2"



SKU: SS316LPFNFLS
PRESSFIT FLANGE
REDUCE SOCKET
3"x2" to 6"x4"



SKU: SS316LPFNCO
PRESSFIT CROSS OVER
15MM, 22MM, 28MM

* Customisation options are available



SKU: SS316LNM05015MX- /
SS316LNM05015FX-
PRESSFIT SINGLE SIDED
MANIFOLDS
2" PIPE X n NOS 1/2" [MI] OR [FI]



SKU: SS316LPFNFE015S
PRESSFIT WALL PLATE
DOUBLE ELBOW
15X 1/2" [FI]



PEX-B/AL/PEX-B THREE LAYER PIPE & FITTINGS (STANDARD: BS EN 21003, SS375)



STRAIGHT PIPE SKU: PIPPEXL
WORKING PRESSURE: MAX 10 BARS



ROLL TYPE SKU: PIPPEX
WORKING PRESSURE: MAX 10 BARS

SKU	OD	ID	Thickness	Length	SKU	OD	ID	Thickness	Length
PIPPEXL16	16MM	12MM	2.0MM	5.8M	PIPPEXL40	40MM	32MM	4.0MM	5.8M
PIPPEXL20	20MM	16MM	2.0MM	5.8M	PIPPEXL50	50MM	41MM	4.5MM	5.8M
PIPPEXL25	25MM	20MM	2.5MM	5.8M	PIPPEXL63	63MM	51MM	6.0MM	5.8M
PIPPEXL32	32MM	26MM	3.0MM	5.8M	PIPPEXL75	75MM	60MM	7.5MM	5.8M

SKU	OD	ID	Thickness	M/Roll	SKU	OD	ID	Thickness	M/Roll
PIPPEX16	16MM	12MM	2.0MM	200M	PIPPEX25	25MM	20MM	2.5MM	100M
PIPPEX20	20MM	16MM	2.0MM	200M	PIPPEX32	32MM	26MM	3.0MM	50M

F6 PUSH-FIT



SKU: PEXF6EC
END CAP
Size availability:
16 to 32mm



SKU: PEXF6E90-
90° EQUAL ELBOW
Size availability:
16 to 32mm



SKU: PEXF6E90-
ELBOW REDUCER
Size availability:
20x16 to 32x25mm



SKU: PEXF6E45016
45° EQUAL SOCKET
Size availability:
16mm

NEW



SKU: PEXF6ES
EQUAL SOCKET
Size availability:
16 to 32mm



SKU: PEXF6RS
REDUCE SOCKET
Size availability:
20x16 to 32x25mm



SKU: PEXF6ET
EQUAL TEE
Size availability:
16 to 32mm



SKU: PEXF6RT
REDUCE TEE
Size availability:
16x16x20 to
32x32x25mm



SKU: PEXF6MIT
MI TEE
Size availability:
16x1/2" to 32x1"



SKU: PEXF6FIT
FI TEE
Size availability:
16x1/2" to 32x1"



SKU: PEXF6MIA
MI ADAPTOR
Size availability:
16x1/2" to 32x1 1/4"



SKU: PEXF6FIA
FI ADAPTOR
Size availability:
16x1/2" to 32x1 1/4"



SKU: PEXF6MIE
MI ELBOW
Size availability:
16x1/2" to 32x1"



SKU: PEXF6FIE
FI ELBOW
Size availability:
16x1/2" to 32x1 1/4"



SKU: PEXF6BV
BALL VALVE
Size availability:
16 to 25mm



SKU: PEXF6FE16
**FI WALLPLATE
ELBOW**
Size availability:
16x1/2" to 25x3/4"



SKU: PEXF6FE-S
**ASSEMBLY DOUBLE
FLANGE ELBOW**
Size availability:
16x1/2" to 20x1/2"



SKU: PEXF6RS
**F5 PRESS-FIT X F6
PUSH-FIT PEX REDUCER**
Size availability:
40x32 to 50x20mm



SKU: PEXF6RT
**F5 PRESS-FIT X F6
PUSH-FIT PEX
REDUCING TEE**
Size availability:
40x40x25 to 40x40x32mm

F5 PRESS-FIT FITTINGS



SKU: PEXF5EC
END CAP
Size availability:
16 to 75mm



SKU: PEXF5E90-
EQUAL ELBOW
Size availability:
16 to 75mm



SKU: PEXF5RE90-
ELBOW REDUCER
Size availability:
20x16 to 63x50mm



SKU: PEXF5ES
EQUAL SOCKET
Size availability:
16 to 75mm



SKU: PEXF5RS
REDUCE SOCKET
Size availability:
20x16 to 75x63mm



SKU: PEXF5ET
EQUAL TEE
Size availability:
16 to 75mm



SKU: PEXF5RT
REDUCE TEE
Size availability:
16x16x20 to
75x75x63mm



SKU: PEXF5MIT
MI TEE
Size availability:
16x1/2" to 50x11/2"



SKU: PEXF5FIT
FI TEE
Size availability:
16x1/2" to 75x21/2"



SKU: PEXF5MIA
MI ADAPTOR
Size availability:
16x1/2" to 75x3"



SKU: PEXF5FIA
FI ADAPTOR
Size availability:
16x1/2" to 75x21/2"



SKU: PEXF5MIE
MI ELBOW
Size availability:
16x1/2" to 63x2"



SKU: PEXF5FIE
FI ELBOW
Size availability:
16x1/2" to 63x2"



SKU: PEXF5FJC
FI UNION
Size availability:
16 to 50x11/2"



SKU: PEXF5FE16
FI WALLPLATE
ELBOW
Size availability:
16x1/2" to 25x3/4"



SKU: PEXF5FE-S
ASSEMBLY DOUBLE
FLANGE ELBOW
Size availability:
16x1/2" to 20x1/2"



SKU: PEXF5BV
BALL VALVE
Size availability:
16 to 25mm



SKU: PEXF5E45-
EQUAL ELBOW
Size availability:
16 to 75mm

MACHINE AND TOOLS



CODE: PEXMR1675
16MM-75MM
"REMS®" PEX
PRESS TOOL



CODE: PEXTCT
MULTILAYER PIPE
CALIBRATION
TOOL/PLATIC REAMER
Size: 16-25MM & 20-32MM



CODE: PEXTBSE
MULTILAYER PIPE
EXTERNAL BENDING
SPRING
Size: 16-32MM



CODE: PEXTBSI
MULTILAYER PIPE
INTERNAL BENDING
SPRING
Size: 16-32MM



CODE: PEXTPT1632
16-32MM MULTILAYER
PIPE LENGTHENED
MANUAL PRESSING
TOOL



CODE: PEXTCW
CLAMP JAW FOR
LENGTHENED MANUAL
PRESSING TOOL
Size: 16-32MM



SKU: PIPHUBE-
EPOXY COATED
HUBLESS PIPE
Size availability:
2" to 12"



SKU: HUBESP-
EPOXY COATED
HUBLESS SHORT PIPE
WITH ACCESS DOOR
Size availability:
3" to 10"



SKU: HUBECT-
EPOXY COATED
HUBLESS CROSS TEE
Size availability:
4"x2", 4"x4", 6"x4"



SKU: HUBEEC-
EPOXY COATED
HUBLESS CAP
Size availability:
2" to 8"



SKU: HUBERS-
EPOXY COATED
HUBLESS REDUCER
Size availability:
3"x2" to 12"x10"



SKU: HUBEB15-
EPOXY COATED
HUBLESS 15DEG BEND
Size availability:
2" to 6"



SKU: HUBEB30-
EPOXY COATED
HUBLESS 30DEG BEND
Size availability:
2" to 6"



SKU: HUBEB45-
EPOXY COATED
HUBLESS 45DEG BEND
Size availability:
2" to 12"



SKU: HUBEB90-
EPOXY COATED
HUBLESS 88DEG BEND
Size availability:
2" to 12"



SKU: HUBEB9010050
EPOXY COATED
HUBLESS 90 DEG BEND
Size availability:
4" x 2"



SKU: HUBEYT-
EPOXY COATED HUBLESS
BRANCH TEE 45DEG
Size availability:
2" to 12"



SKU: HUBEET-/HUBERT-
EPOXY COATED HUBLESS
BRANCH TEE 88DEG
Size availability:
2" to 10"



SKU: HUBEPT100
EPOXY COATED
HUBLESS P TRAP
Size availability:
4"x4"



SKU:HUBEPT10050
EPOXY COATED
HUBLESS P TRAP
Size availability:
4"x2"



SKU:HUBEST100
EPOXY COATED
HUBLESS S TRAP
Size availability:
4"



SKU:HUBEST10050
4"x2" EPOXY COATED
HUBLESS S TRAP
(First Generation)



SKU:HUBEST10050
4"x2" EPOXY COATED
HUBLESS S TRAP
(Second Generation)



SKU:EPCP
HUBLESS EPOXY PIPE
ANTI-CORROSION
SEALING PAINT

FITTINGS MATERIAL: AISI304/ CARBON STEEL



SKU: HUBC
TYPE A CLIPS
Size availability:
2" to 12"



SKU: HUBC
TYPE A REDUCE CLIPS
Size availability:
2"x1 1/2" to 4"x3"



SKU: HUBC-B
TYPE B RAPID COUPLING
Size availability:
2" to 12"



SKU: HUBC-F
TYPE F HIGH RISE CLIPS
Size availability:
2" to 8"



SKU: HUBKV
KOMBI GRIP COLLAR
Size availability:
2" to 6"



SKU: HUBKV
KOMBI GRIP COLLAR
Size availability:
8" to 12"



SKU:HUBRTW516
TORQUE WRENCH
FOR HUBLESS CLIP

NEW



ZPC - EPOXY AND ZINC COATED CAST IRON HUBLESS PIPE & FITTINGS



SKU: PIPHUBZ-
EPOXY AND ZINC
COATED HUBLESS PIPE
Size availability:
2" to 12"



SKU: HUBEZP-
EPOXY AND ZINC COATED
HUBLESS SHORT PIPE
WITH ACCESS DOOR
Size availability:
3" to 10"



SKU: HUBZCT-
EPOXY AND ZINC COATED
HUBLESS CROSS TEE
Size availability:
4"x2", 4"x4", 6"x4"



SKU: HUBZEC-
EPOXY AND ZINC
COATED HUBLESS CAP
Size availability:
2" to 8"



SKU: HUBZRS-
EPOXY AND ZINC
COATED HUBLESS
REDUCER
Size availability:
3"x2" to 12"x10"



SKU: HUBZB15-
EPOXY AND ZINC
COATED HUBLESS
15DEG BEND
Size availability:
2" to 6"



SKU: HUBZB30-
EPOXY AND ZINC COATED
HUBLESS 30DEG BEND
Size availability:
2" to 6"



SKU: HUBZB45-
EPOXY AND ZINC
COATED HUBLESS
45DEG BEND
Size availability:
2" to 12"



SKU: HUBZB90-
EPOXY AND ZINC
COATED HUBLESS
88DEG BEND
Size availability:
2" to 12"



SKU: HUBZB9010050
EPOXY AND ZINC
COATED HUBLESS 90
DEG BEND
Size availability:
4" x 2"



SKU: HUBZYT-
EPOXY AND ZINC COATED
HUBLESS BRANCH TEE
45DEG
Size availability:
2" to 12"



SKU: HUBZET-/ HUBZRT-
EPOXY AND ZINC COATED
HUBLESS BRANCH TEE
88DEG
Size availability:
2" to 10"



SKU: HUBZPT100
EPOXY AND ZINC COATED
HUBLESS P TRAP
Size availability:
4"x4"



SKU: HUBZPT10050
EPOXY AND ZINC
COATED HUBLESS
P TRAP
Size availability:
4"x2"



SKU: HUBZST100
EPOXY AND ZINC
COATED HUBLESS
S TRAP
Size availability:
4"



SKU: HUBZST10050
4"x2" EPOXY AND ZINC
COATED HUBLESS
S TRAP
(First Generation)



SKU: HUBZST10050
4"x2" EPOXY AND ZINC
COATED HUBLESS
S TRAP
(Second Generation)

norika® **CAST IRON HUBLESS PIPE & FITTINGS**



SKU: PIPHUB
HUBLESS PIPE
Size availability: 2"-12"



SKU:HUBB90
HUB BEND 90DEG
Size availability: 2"-12"



SKU:HUBB9010050
HUB BEND 90DEG
Size availability: 4"X2"



SKU:HUBB45
HUB BEND 45DEG
Size availability: 2"-8"



SKU:HUBRS
HUB REDUCER
Size availability:
3"X2" - 8"X6"



SKU: HUBEC
HUB END CAP
Size availability: 2"-8"



SKU:HUBYT
HUB Y TEE
Size availability:
2"x2" ~ 10"x8"



SKU:HUBCT
HUB CROSS TEE
Size availability:
4"X2", 4"X4", 4"X3", 6"X4"



SKU:HUBET
HUB EQUAL TEE
Size availability: 2"-8"



SKU:HUBRT
HUB REDUCE TEE
Size availability: 2"-8"



SKU:HUBSP
HUB SHORT PIPE
Size availability: 2"-8"



SKU:HUBST10050
HUB S TRAP
Size availability: 4"X2"



SKU:HUBPT10050
HUB P TRAP
Size availability: 4"X2"



SKU:HUBPT100
HUB P TRAP
Size availability: 4", 4"X3"



SKU:HUBST100
HUB S TRAP
Size availability: 4"



SKU:HUBPT1008050
HUB P TRAP
Size availability: 4"X3"X2"



SKU:CIPT150100
CAST IRON P TRAP
Size availability: 4", 6"X4"



SKU:CIST150100
CAST IRON S TRAP
Size availability: 4", 6"X4"

COUPLINGS & CLAMPS

MATERIAL: AISI304



SKU: SSHRC
 AISI304 HALF
 REPAIR CLAMP
 Size availability:
 13-15mm to 575-600mm



SKU: SSFRC
 AISI304 FULL
 REPAIR CLAMP
 Size availability:
 32-39mm to 410-420mm



SKU: SSC100
 STAINLESS STEEL
 HOSE CLIP
 Size availability:
 6-12mm to 155-311mm



SKU: VCPSSC-
 VITRIFIED CLAY PIPE AISI316L
 FLEXSEAL CLIPS
 Size availability:
 150mm, 225mm

MATERIAL: BRASS



SKU: CFRCN
 BRASS REPAIR CLAMP
 Size: 15mm TO 54mm

MATERIAL: DUCTILE IRON



SKU: DIFC-EPC
 HEAVY DUTY DUCTILE IRON
 FLEXIBLE COUPLING C/W
 EPOXY COATED
 Size availability:
 3" to 16"



SKU: DIFA-EPC
 HEAVY DUTY DUCTILE IRON
 FLANGE ADAPTOR C/W
 EPOXY COATED
 Size availability:
 3" to 16"

WATER METERS



SKU: WMN-D
 SINGLE JET DRY DIAL
 COLD WATER METER
 [SCREW END]
 [13D]



SKU: WMN015-PD
 1/2" BRASS SINGLE JET
 DRY DIAL COLD
 WATER METER



SKU: WMN
 WATER METER
 [SCREW END]
 1/2" to 2"



SKU: WMNF-WP
 WATER METER
 [FLANGE END]
 21/2" to 8"



SKU: WMSN-V
 SMART WATER METER WITH
 MODBUS RTU OUTPUT
 [SCREW END]
 Size: 15mm to 35mm



SKU: WMSN-V
 SMART WATER METER WITH
 MODBUS RTU OUTPUT
 [SCREW END]
 Size: 42mm



SKU: WMSN-FV
 SMART WATER METER WITH
 MODBUS RTU OUTPUT
 [FLANGE END]
 Size: 50mm to 200mm



SKU: WMSN
 SMART WATER METER WITH
 MODBUS RTU OUTPUT
 [SCREW END]
 Size: 15mm to 50mm



SKU: WMSN-F
 SMART WATER METER WITH
 MODBUS RTU OUTPUT
 [FLANGE END]
 Size : 50mm to 200mm



SKU: WMSUN
 ULTRASONIC WATER
 METER [SCREW END]
 Size : 15mm to 42mm



SKU: WMSUN-F
 ULTRASONIC WATER
 METER [FLANGE END]
 Size : 50mm to 150mm



SKU: WMNC
 WATER METER
 BRASS CONNECTOR
 1/2" x 295MM, 1/2" x 55MM,
 3/4" x 50MM



SKU: PG
STANDARD DRY
PRESSURE GAUGE



SKU: PG-OF
STAINLESS STEEL
CASING OIL FILLED
PRESSURE GAUGE



SKU: PGM
STAINLESS STEEL
CASING MICROMANO
PRESSURE GAUGE
0~7PSI



SKU: PG-030
STAINLESS STEEL
CASING MICROMANO
PRESSURE GAUGE
0~30PSI



SKU: PGB065150
1/4"X60MM DRY
PRESSURE GAUGE
[BACK CONNECTION]



SKU: PGABT006D90
STAINLESS STEEL
PRESSURE GAUGE
BUFFER TUBE



SKU: PGAS
STAINLESS STEEL
PRESSURE GAUGE
SNUBBER
Size: 1/4", 1/2"



SKU:AB-R
INFLATABLE BLUE
RUBBER TESTING BAG
2" to 12"



SKU:AB-R1
INFLATABLE BLACK
RUBBER TESTING BAG
4" & 6"



SKU:AB100RL
INFLATABLE BLACK
RUBBER TESTING BAG
4" (LONG)



SKU:ABSEW150P
INFLATABLE RUBBER
TESTING BALLOON
6"



SKU:ABSEW100-150
INFLATABLE RUBBER
TESTING BALLOON
4" & 6"



SKU:AB-RPX2
4", 6" INFLATABLE
BLACK RUBBER DRAIN
TESTING BAG
(AB-RP1+AB-R1)



SKU:AB-RP1
INFLATABLE BLACK
RUBBER DRAIN
TESTING BAG
4" & 6"



SKU:AB-RP
INFLATABLE BLUE
RUBBER TESTING BAG
2"X1/2" to 8"X1/2"



SKU:TP
CENTRE LOCKING
DRAIN TEST PLUGS
20mm & 25mm



SKU:TP
CENTRE LOCKING
DRAIN TEST PLUGS
42mm to 375mm



SKU:TP
CENTRE LOCKING &
MULTI-LOCKING
DRAIN TESTING PLUGS
400mm to 600mm



SKU:TP
CENTRE LOCKING &
MULTI-LOCKING
DRAIN TESTING PLUGS
700mm to 1200mm



SKU:TPN
HYDRAULIC PRESSURE
TESTING PUMP
1500PSI



SKU: TPNM
MOTORISED POWER
TEST PUMP



SKU: BRCT015MFCP
CROSS-TYPE WATER
DIVERTER C/W SWIVEL FEMALE



SKU: UG500
U GAUGE (-250~250mm)



SKU:ABAHP
HIGH PRESSURE MINI HAND-HELD
MULTI-FUNCTION AIR PUMP



SKU:ABAFP
MULTI-FUNCTION AIR
FILLER PUMP



SKU: GIP
GI PLUG
1/2" TO 2"



SKU: GIE90
90DEG GI ELBOW
1/2" TO 4"



SKU: GIE45
45DEG GI ELBOW
1/2" TO 4"



SKU: GIES
GI SOCKET
1/2" TO 2 1/2"



SKU: GIET
GI EQUAL TEE
1/2" TO 4"



SKU: GIRT
GI REDUCING TEE
1" x 1/2" TO 2" x 1"



SKU: GIU
GI UNION
1/2" TO 2 1/2"



SKU: GIEN
GI NIPPLE
1/2" TO 4"



SKU: GIRB
GI BUSH
1/2" x 3/8" TO 2" x 1 1/2"



SKU: GIEC
GI CAP
1/2" TO 2"

STAINLESS STEEL 304/316 FITTING



SKU: SS304SP
AISI304 PLUG
1/2" TO 4"



SKU: SS304E90
90 DEG ELBOW
1/2" TO 4"



SKU: SS304E45
45 DEG ELBOW
1/2" TO 2 1/2"



SKU: SS304ES
AISI304 SOCKET
1/2" TO 4"



SKU: SS304ET
AISI304 EQUAL TEE
1/2" TO 4"



SKU: SS304RS
AISI304 REDUCING
SOCKET
3/4" x 1/2" TO 2" x 1 1/2"



SKU: SS304RT
AISI304 REDUCING TEE
3/4" x 1/2" TO 2" x 1 1/2"



SKU: SS304U
AISI304 UNION
1/2" TO 3"



SKU: SS304UMF
AISI304 UNION M/F
1/2" TO 2 1/2"



SKU:
SS304EN/SS316EN
AISI304/AISI316
NIPPLE
1/2" TO 4"



SKU: SS304RN
AISI304 R/NIPPLE
3/4" x 1/2" TO 2" x 1 1/4"



SKU: SS304RB
AISI304 BUSH
1/2" x 3/8" TO 4" x 3"



SKU: SS304ES-MF
AISI304 EQUAL
SOCKET M/F
1/2" TO 2"



SKU: SS304SE-MF
AISI304 STRAIGHT
ELBOW [MXF]
1/2" TO 2"



SKU: SS304E9015MM
AISI304 EQUAL
(MALE) ELBOW
1/2"



SKU: SS304ENFIT0505015
2"(L)x2"(R)x1/2" EQUAL
NIPPLE FI TEE



SKU: SS304KCN
AISI304 PLATED
COMBINATION HOSE
NIPPLE
1/2" TO 4"



SKU: SS304CT
AISI304 HEXAGONAL
EQUAL CROSS TEE
1/2" TO 2"

MATERIAL: GALVANISED IRON



SKU: GIBC/ GIBC-B
GALVANIZED IRON
BEAM CLAMP
Size availability:
1/2" & 3/8"



SKU: CPCN1
"QUICK FIT" COPPER
PIPE CLAMP
Size availability:
3/8" to 1 1/2"



SKU: CPCN1
"QUICK FIT" COPPER
PIPE CLAMP
Size availability:
2" to 14"



SKU: PCTA-GI
PIPE CLAMP C/W
HOT DIPPED
GALVANIZED TYPE "A"
Size availability:
2" to 10"



SKU: PHD
BAND HANGER
Size availability:
1" to 12"



SKU: PCTAR
PIPE CLAMP C/W HOT
DIPPED GALVANIZED
TYPE "A" WITH RUBBER
Size availability:
2" to 8"



SKU: PCTC-GI
PIPE CLAMP C/W
HOT DIPPED
GALVANIZED TYPE "C"
Size availability:
2" to 8"



SKU: PCTD-GI
PIPE CLAMP C/W HOT
DIPPED GALVANIZED
TYPE "D"
Size availability:
2" to 8"



SKU: LB17
GALVANISED
IRON LB BEND
Size availability:
3/4"X10M

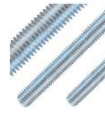

SKU: GIS
GALVANISED
IRON STUB ROD
1/4" to 7/8",
M8 to M16



SKU: GIW
GI WASHER
1/4" TO 7/8",
M6 to M16



SKU: GIUB
GI U-BOLT & NUT
1/2" to 7/8"



SKU: GISTS
GI SELF TAPPING
SCREW
Lengh: 1", 1 1/4", 1 1/2", 2"



SKU: GIN
GI & S/STEELNUT
1/4" to 7/8", M6 TO M16



SKU: GILN
GI LONG NUT
1/4" TO 5/8",
M8 TO M16



SKU: DIA
GI DROP IN
ANCHOR: 1/4" to
5/8", M6 to M12



SKU: GIBN
GI BOLT & NUT
1/2" to 7/8"



SKU: NBB
BASIN BRACKET



SKU: RP
GI RAW PLUG
1/4" to 5/8"



SKU: RP14H
GI SLEEVE RAW
PLUG
1/4" to 5/8"

MATERIAL: BRASS / COPPER:



SKU: BROCC/ BROCC-CP
BRASS O CLIP
Size availability:
1/2" to 1 1/4"



SKU: CSC
COPPER SADDLE CLIP
Size availability:
1/2" to 1"



SKU: BSTS1
M4x25MM BRASS
SELF TAPPING
SCREW

MATERIAL: AISI304 / AISI316



SKU: CPCN1-SS304/316
 AISI304/316 "QUICK FIT"
 COPPER PIPE CLAMP
 Size availability:
 3/8" to 1 1/2"



SKU: CPCN1-SS304/316
 AISI304/316 "QUICK FIT"
 COPPER PIPE CLAMP
 Size availability:
 2" to 14"



SKU: PCTE-SS304
 AISI304 TYPE
 E PIPE U CLAMP
 2" to 6"



SKU: CBSS-SS
 AISI304 COLLAR
 BRACKET
 Size availability:
 1/2" to 2"



SKU: PCTC-SS304
 AISI304 PIPE CLAMP
 Size availability:
 2" to 8"



SKU: PCTD-SS304
 AISI304 PIPE CLAMP
 Size availability:
 2" to 8"



SKU: PHD-SS304
 AISI304 BAND HANGER
 Size availability:
 1" to 12"



SKU: SSW
 AISI304 WASHER
 1/4" TO 7/8",
 M6 to M16



SKU: SSUB
 AISI304
 U-BOLT & NUT
 1/2" to 7/8"



SKU: SSS
 AISI304 STUB ROD
 1/4" to 7/8", M8 to M16



SKU:
RCSN-SSCARM08SS316
RCSN-SSCARM10SS316
RCSNA-SSCARM12SS316
 AISI316 CARABINER



SKU:
RCSN-EBM1036
RCSNA-EBM1636
 AISI316 ANCHOR SLEEVE



SKU:
RCSN-SSDIAM10125SS316
 AISI316 DROP IN ANCHOR



SKU: SSDIA
 S/STEEL 304 OR 316
 DROP IN ANCHOR
 1/4" to 5/8", M6 to M12



SKU: SSN
 GI & S/STEELNUT
 1/4" to 7/8", M6 TO M16



SKU: NA533SS
 STAINLESS STEEL
 NYLON ANCHOR



SKU: SSRP
 S/STEEL RAW
 PLUG: 1/4" to 5/8",
 M6 to M12



SKU: SS316STS114
 S/STEEL 316 SELF
 TAPPING SCREW
 SIZE: ST4



SKU: SSBNWM-316L
 S/STEEL AISI316
 HEXAGONAL BOLT &
 NUT WITH 2 AISI316
 WASHER

MATERIAL: Q235



SKU: UCH
 UPVC COATED
 HOLDERBAT
 2" to 6"

MATERIAL: PLASTIC



SKU: 141UC
 PVC U CLIP (WHITE)
 FOR SS141 PIPE
 Size availability:
 1/2" to 2"



SKU: AEUC
 PVC U CLIP (GREY)
 FOR AW/AE PIPE
 Size availability:
 1/2" to 2"



SKU: 141SC
 SHACKLE CLIP FOR
 SS141 PIPE, COPPER
 PIPE
 & S/STEEL PIPE
 Size: 3/8" to 1"



SKU: CBSS/ CBPPR
 NYLON COLLAR
 BRACKET
 Size: 1/2" to 2, 3/4" to 2"



SKU: 141OC
 O CLIP
 Size availability:
 15 ~ 25mm



SKU: RP/ GP
 PE RAW PLUG
 Red: M6x25MM
 Green: M7x25MM

UNISTRUT & ACCESSORIES:

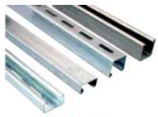

SKU: OL
UNISTRUT CHANNEL
OL & C/W SLOTTED
41MMX41MM,
41MMX21MM



SKU: OLSBA100
UNISTRUT ANGLE
BRACKET
100MMX90MM
X2 HOLE



SKU: OLSBA050
UNISTRUT ANGLE
BRACKET
50MMX50MM
X1 HOLE



SKU: OLSNM10
UNISTRUT LONG
SPRING CHANNEL NUT
3/8" & M10



SKU: OLEC
UNISTRUT PVC
END CAP
21MM & 41MM



SKU: OLHB21
UNISTRUT
HOLDING
COVER



SKU: OLES4141
UNISTRUT END SMALL
SUPPORT BRACKET
150X70MM



SKU: OLESB4141
UNISTRUT END BIG
SUPPORT BRACKET
150X150MM



SKU: OLSB1065
80x40MM UNISTRUT
END SUPPORT
BRACKET



SKU: OLW4040
40x40MM UNISTRUT
END SUPPORT
BRACKET



SKU: OLSC
GI OLISTRUCT
CLAMP
Size availability:
1/2" to 6"



SKU: WN
WEDGE NUT
3/8" & M10



SKU: OLUB
UNISTRUT BEAM
CLAMP / SINGLE U-
BOLT ASSEMBLY



SKU: OLCTB
UNISTRUT C TYPE
BRACKET (FOR CABLE
TRAY)



SKU: OLSACB
UNISTRUT
90° CORNER
MOUNTING BRACKET



SKU: OLSBA090
UNISTRUT 90°
MOUNTING BRACKET



SKU: OLSBA09045
UNISTRUT 45°
MOUNTING BRACKET



SKU: OLCB4141
UNISTRUT U-SHAPED
CONNECTOR
BRACKET



SKU: OLFLP
UNISTRUT FLAT L
PLATE BRACKET



SKU: OLFCB
F CLIP



NEW

SKU: OLSB1067
UNISTRUT 4
HOLE SLOTTED
SPLICE PLATE



NEW

SKU: OLSBT1031
UNISTRUT 4 HOLE T
FLAT SLOTTED
SPLICE PLATE

FLAT BAR / ANGLE BAR:



SKU: AFB25
ALUMINIUM FLAT BAR
1"X1/8"THK X 20FT



SKU: GIFB
GI FLAT BAR
1"X3MM to 2" X 3.2MM



SKU: GIAB
GI ANGLE BAR
1"X2.5MM to 2"X4.2MM



SKU: GICC
GI C CHANNEL BAR
2"X1"X4.0MM to 4"X2"X4.7

GREASE TRAPS:

1. MATERIAL: ALUMINIUM



SKU: RCGTC1050AF
GREASE TRAP FRAME
& COVER 1050



SKU: RCGTC1800AF
CHEQUER PLATED
GREASE TRAP FRAME
& COVER 1800



SKU: RCGTCSC
CHEQUER PLATE SCREEN
CHAMBER FRAME & COVER
1000x800 MM

2. MATERIAL: GALVANISED IRON MILD STEEL



**SKU: RCGTC1050MSAF,
RCGTC1050MSHD20AF**
GREASE TRAP FRAME &
COVER 1050



**SKU: RCGTC1050MSAF,
RCGTC1050MSHD20AF**
GREASE TRAP FRAME &
COVER 1050 [RECESSED]



**SKU: RCGTC1800MSAF,
RCGTC1800MSHD40AF**
CHEQUER PLATED
GREASE TRAP FRAME &
COVER 1800



**SKU: RCGTC1800MSAF,
RCGTC1800MSHD40AF**
GREASE TRAP FRAME &
COVER 1800 [RECESSED]



**SKU: RCGTCSCMS,
RCGTCSCMSHD40**
CHEQUER PLATE SCREEN
CHAMBER FRAME & COVER

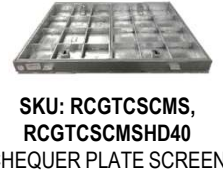

**SKU: RCGTCSCMS,
RCGTCSCMSHD40**
CHEQUER PLATE SCREEN
CHAMBER FRAME & COVER
[RECESSED]

3. MATERIAL: AISI304



SKU:RCGTCSCSS
AISI304 CHEQUER PLATE
SCREEN CHAMBER
FRAME & COVER

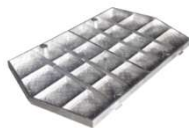

SKU: RCGTC1050SSAF
AISI304 GREASE TRAP
FRAME & COVER 1050
RECESS MOSAIC TILING

MANHOLE COVERS:

1. MATERIAL: AISI304 OR AISI316L *Customisation options are available

AIRTIGHT & WATERTIGHT:



SKU: SSRICC
AISI304 / AISI316L
LIGHT/HEAVY DUTY IC
COVER [RECESSED]
700x550x60MM



SKU: SSMDRMC
S/STEEL 304/316L MEDIUM
DUTY MANHOLE COVER
[RECESSED]
750x750x90MM



SKU:SSHDRMC
S/STEEL 304 OR AISI316L
HEAVY DUTY MANHOLE
COVER [RECESSED]
800x800x140MM



SKU: SSHDTC-A1
AISI304 OR AISI316L
[HEAVY DUTY] TELECOM
COVER [RECESSED]
CLEAR
OPENING:910MMX610MM



SKU: SSRICCAT
AISI304 OR AISI316L
LIGHT/HEAVY DUTY IC
COVER [RECESSED & AIR/
WATER TIGHT]
700x550x60MM



NEW

SKU: SSMDMC-A2
S/STEEL 304 OR 316
MEDIUM DUTY DOUBLE
TRIANGULAR MANHOLE
COVER & FRAME
750x750x90MM



NEW

SKU: SSHDMC-A1
S/STEEL 304 OR 316
MEDIUM DUTY DOUBLE
TRIANGULAR MANHOLE
COVER & FRAME
800x800x140MM

2. MATERIAL: DUCTILE IRON

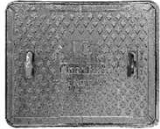

SKU: DIICCS
DUCTILE IRON LIGHT
DUTY INSPECTION
COVER & FRAME
C OR A2 GRADE
700x550x40MM



SKU: DIRICC
DUCTILE IRON LIGHT DUTY
RECESSED INSPECTION
COVER & FRAME
700x550x60MM



SKU: DIMDMC
DUCTILE IRON MEDIUM
DUTY MANHOLE COVER
B125 OR A2
750x750x75MM



SKU: DIHDMC
DUCTILE IRON HEAVY
DUTY MANHOLE COVER
F900, A1, A2 GRADE
800x800x140MM



SKU: DIMDMCA2
DUCTILE IRON MEDIUM
DUTY MANHOLE COVER
750x750x90MM



SKU: DIMDRMC
DUCTILE IRON MEDIUM
DUTY MANHOLE COVER
[RECESSED] B125 OR A2
750x750x90MM



SKU: DIHDRMC
DUCTILE IRON HEAVY
DUTY MANHOLE COVER
[RECESSED] A1 OR A2
GRADE: 800x800x140MM



SKU: DIMC
DUCTILE IRON
MANHOLE COVER
[CIRCULAR] A1
850x850x100MM

AIR TIGHT & WATER TIGHT:



SKU: DIMCATD400-R
DUCTILE IRON
HEAVY DUTY AIR TIGHT
MANHOLE COVER
C/O 600MM, 1000MM



SKU: DIMCATD400
DUCTILE IRON
HEAVY DUTY AIR TIGHT
MANHOLE COVER
C/O OPENING SIZE:
600, 800, 1000, 1200MM,
910x610MM, 1700x1250MM



SKU: DIMCATRD400-
DUCTILE IRON HEAVY
DUTY AIR TIGHT
RECESSED MANHOLE
COVER
C/O 600MM, 800MM,
1000MM

DUCTILE IRON VALVE BOX:



SKU: DIDVB-D400
HEAVY DUTY DUCTILE
IRON [DOUBLE] VALVE
BOX



SKU: DISVB-R
DUCTILE IRON
SINGLE VALVE BOX
PUB/GAS/FH [ROUND]



SKU: DISVB-A1
DUCTILE IRON
SINGLE VALVE BOX
PUB/GAS/FH
465MMX300MM



SKU: DISCC200
DUCTILE IRON
STOPCOCK COVER
8"X8"



SKU: DISVPUB210-A1
SINGLE VALVE BOX
SQUARE TOP
210MMx210MM

COVER ACCESSORIES:



SKU: CIGT9417/159
9"X4"X17", 15"X9"
DUCTILE IRON HEAVY
DUTY GULLY TRAP



SKU: CIGTS0811/CIGTS0811S
/ **CIGTS25050**
"NORIKA®" 7"X11"
& 12"X24" ALUMINIUM
& S/STEEL STRAINER

* Customisation
options are
available



SKU: RCGTC1050ASB
AISI304 BUCKET FOR
1050MM GREASE TRAP



SKU: RCGTC1800ASB
AISI304 BUCKET
FOR 1800MM GREASE TRAP
475MMX405MMX300MM



SKU: RCSH
ALUMINIUM SAFTY
HANDRAIL



SKU: RCSH-316L
AISI316 SAFTY
HANDRAIL



SKU: RCSN
MANHOLE SAFETY
NETTING
Size: ≤ 600x600mm



SKU: RCSN
MANHOLE SAFETY
NETTING
Size: > 600x600mm



SKU: RCSNA
MANHOLE SAFETY
ROPE



SKU: MHK
GALVANIZED
MANHOLE KEY



SKU: MHKSS
AISI304
MANHOLE KEY
(PVC COATED)



SKU: MHKS
KEY HOLE'S COVER
FOR MANHOLE



SKU: GLICG650
650MM H.D. GAL. MILD
STEEL LAST IC
MANHOLE GRATING



SKU: RCGTC1050ASG
GREASE TPAP ACCESSORIES
MILD STEEL C/W HOT DIPPED
GAL SCREEN GRATING ONLY
500MMX695MM



SKU: VJEB15
INSIDER HYDRO
FOR SPA POOL
15MM



SKU: VJEB
INSIDER HYDRO
FOR SPA POOL [BLACK
& WHITE COLOUR]
20MM & 25MM



SKU: VJEB
[TESTING CAP]
FOR INSIDER HYDRO
SPA POOL



SKU: VJSC50
50MM SPA POOL
SUCTION PVC
DOME COVER



SKU: VJFI
SWIMMING POOL
FLOOR INLET [BLACK
& WHITE COLOUR]
50MM



SKU: VJFICS316
SWIMMING POOL
FLOOR INLET S/STEEL
AISI316 COVER
50MM



SKU: VJLC85
"NORIKA®" S/STEEL
304 LAMP COVER
Ø85MM



SKU: VJSSAV
S/STEEL AIR VENT
FOR SPA POOL



SKU: BJN15
AISI304/316 JET NOZZLE
FAN SHAPED



SKU: BJN
BRASS JET NOZZLE



SKU: BJN-SS
S/STEEL 304 /316
JET NOZZLE



SKU: VJEB0
AISI304 AIR BLOWER
COVER OPENER
FOR SPA POOL



SKU: LBBSS
S/STEEL SS304
LIFE BUOY BRACKET



SKU: VJDR
SUPPORT RUBBER BASE
FOR SWIMMING POOL
OVERFLOW DRAIN COVER



S/STEEL SPA POOL
SUCTION GRATING
HEAVY DUTY



SKU: VJ
VENTURI JET AIR TUBE
FOR VENTURI JET



SKU: VJMJ
15MM SPA POOL
MINI JET



SKU: VJC
SPA POOL CLEANER



SKU: SSCLN
AISI304 OR AISI316
CAT LADDER
900MM to 3900MM



*** Customisation options are available**

SKU: SSDG
AISI316L DRAIN GRATING

AISI304 STRAINER BASKET (Size could be customized)



SKU: SSSPFN-R
AISI304 STRAINER
BASKET FOR SWIMMING
POOL C/W U HANDLE



SKU: SSSPFN-RM
AISI304 STRAINER
BASKET FOR SWIMMING
POOL C/W STRAIGHT
HANDLE



SKU: SSSPFN-S5
AISI304 STRAINER
BASKET FOR SWIMMING
POOL SQUARE COLLAR
C/W STRAIGHT HANDLE



SKU: SSSPFN-S12
AISI304 STRAINER BASKET
FOR SWIMMING POOL
12MM HOLE/ SQUARE
COLLAR C/W STRAIGHT
HANDLE



SKU: SSSPFN-R12
AISI304 STRAINER
BASKET FOR SWIMMING
POOL 12MM HOLE C/W
STRAIGHT HANDLE

RUBBER GASKET:



SKU:RFGN
FULL FACE FLANGE
RUBBER GASKET
(NORIKA)
2" to 12"



SKU:RFG
FULL FACE
FLANGE RUBBER
GASKET (LC)
2" to 12"



SKU:RFGN-PUB
FLAT RUBBER GASKET
WITH 2 HOLES FOR
POTABLE WATER
2" to 12"



SKU:RFGN-PUB-F
FULL FACED FLANGE
RUBBER GASKET (NORIKA)
FOR POTABLE WATER
2" to 12"



SKU: RTW
RUBBER WASHER
3/8", 1/2" & 3/4", 10MM //
BASIN TAP WASHER FOR
PILLAR MOUNTING



SKU: RB
RUBBER BLOCK
FOR PUMP
3//X21/2"X1"
5"X5"X3/4"
9"x9"x3/8"

EXPANSION JOINT: Galvanized Iron



SKU:FEJN
SINGLE-SPHERE
FLANGED RUBBER
EXPANSION JOINT
1 1/2" to 14"



SKU: FEJNT
DOUBLE SPHERE
FLANGED RUBBER
EXPANSION JOINT
1 1/2" to 12"



SKU:UEJ
TWIN SPHERE
UNION RUBBER
EXPANSION JOINT
1/2" to 3"

Cast Steel (Epoxy Coated)



SKU: UEJN
"QUICK HUBBED" & EPOXY
COATED FEMALE THREADED
UNION EXPANSION JOINT
1/2" to 2 1/2"

EXPANSION JOINT: AISI304



SKU: UEJ-S
AISI304 TWIN SPHERE
UNION RUBBER
EXPANSION JOINT
1/2" to 3"



SKU: UEJN-S
AISI304 "QUICK HUBBED"
& THREADED UNION
EXPANSION JOINT
1/2" to 2"



SKU: FTN-300
STAINLESS STEEL
FLEXIBLE CONNECTOR
1"x300mm to 2"x300mm

MATERIAL: UPVC



SKU: AWBF
AW BLANK FLANGE
Size availability:
1 1/2" to 8"



SKU: AWSOF
AW SLIP ON FLANGE
Size availability:
2" to 12"

MATERIAL: AISI304



SKU:SSFPN16
AISI304 FLANGE PN16
WITH THREADED
42X15MM to 200X200MM



SKU: SSFPN16BF
AISI304 BLANK
FLANGE PN16
1/2" to 12"



SKU: SSFPN16-SO
AISI304 FLANGE PN16
2", 3", 4", 6"

MATERIAL: BRASS/ BRONZE



SKU:BFPN16
BRASS FLANGE PN16
WITH THREADED
1/2" to 6"



SKU:BFPN16MBL
BRONZE FLANGE PN16
FLAT JOINT
1/2" to 6"

MATERIAL: DUCTILE IRON



SKU: DIFHV
HEAVY DUTY
DUCTILE IRON HV THREAD
SCREW ON FLANGE
Size availability:
3" to 6"



SKU: DIFMBL
HEAVY DUTY
DUCTILE IRON FLANGE
FOR MBL FLANGE SOCKET
Size availability:
2" to 2 1/2"



SKU: DIFSO-THK15
HEAVY DUTY DUCTILE
IRON SLIP ON FLANGE
Size availability:
3" to 6"



SKU: DIFBF
HEAVY DUTY
DUCTILE IRON
BLIND FLANGE
Size availability:
2" to 12"



SKU: DIFBSPT
HEAVY DUTY DUCTILE
IRON COMPANION
FLANGE
Size availability:
1 1/2"x42mm to 6"x150mm



SKU:CR2330
"NORIKA"
7/8"X5FT
CLEANING ROD



SKU: CRAW
[CLEANING ROD
ACCESSORIES]
WHEEL



SKU: CRAJ
[CLEANING ROD
ACCESSORIES]



SKU:CRAP100
[CLEANING ROD
ACCESSORIES]
RUBBER PLUNGER



SKU: CRADS
[CLEANING ROD
ACCESSORIES]
4" DROP SCRAPER



SKU: CRADWS
[CLEANING ROD
ACCESSORIES]
2" DOUBLE
WORM SCREW



SKU: CRAN15
[CLEANING ROD
ACCESSORIES]
7/8"X2" S/STEEL
WATER JET



SKU:SR1530
"NORIKA"
1/2"X30FT
SPRING ROD



SKU: FSL
"NORIKA"
NYLON SAFETY
BELT



SKU: CPE
COPPER EXPANDER
1/2"X3/4", 1/2"X3/4"X1",
1", 1 1/4", 1 1/2", 2"



SKU: ST10
SEALING TAPE
3/4"X10M



SKU: MT5025Y
MASKING TAPE
2"X25M



SKU: DWDN100
4" DIAMOND
CUTTING DISC



SKU: CD
FIBER CUTTING DISC
4", 7", 12", 14", 16"



SKU: MT50
MEASURING TAPE
5.0M x 25mm



SKU: S2215 / S2815
SPANNER



SKU:SD
SCREW DRIVER +/-
4" & 6"



SKU:AS
ADJUSTABLE
SPANNER



SKU: MAPTOR
WELDING TORCH



SKU: MAPPGAS
MAPP GAS



SKU: CPBSB
PORTABLE COPPER PIPE
BENDER SUPPORT BASE



SKU: CPB1520
1/2"X3/4" COPPER
PIPE BENDER



SKU: CPBB
COPPER PIPE BENDER
BRIDGE/Form
1/2", 3/4", 1"



SKU:FHRB
FIRE HOSE CABINET



SKU: VK
VALVE KEY A

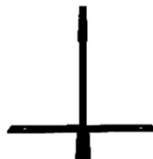

SKU: VK0300-1500
INTERMEDIATE PIECE
UNDERGROUND VALVE
KEY B



SKU: VKSS
AISI304 INTERMEDIATE
PIECE UNDERGROUND
VALVE KEY B
HEIGHT: 300-2450MM



SKU: HGC
[KNITTED COTTON]
HAND GLOVE



SKU: WX102
PRECHARGE PRESSURE
TANK IN LINE PN10 24L
CAPACITY



SKU: PVCS
PVC SHEET



SKU: PFM15-100
PRESS FIT MACHINE
MACHINE MODEL:
15-108MM



SKU: PCN
RED COLOUR COPPER
TUBE CUTTER
OD: 3-28MM, 5-50MM,
6-70MM



SKU: PCN-PVC
RED COLOUR HEAVY
DUTY PVC PIPE CUTTER
OD: 3MM-42MM, 3MM-63MM



SKU: PCN3
MULTILAYER PIPE
CUTTER
32MM



SKU: PCN20-63PVC
2 1/2" HEAVY DUTY UPVC
PIPE CUTTER



SKU: MHCL
MANHOLE COVER LID
LIFTER



SKU: MHCLD
MANHOLE COVER
MAGNETIC LID LIFTER
DOLLY

ERA[®] FITTING (STANDARD:AS/NZS 1477) TESTED SS 174:2014

COUNTRY OF ORIGINAL:CHINA



SKU: 1477ES
SCH40 EQUAL SOCKET
Size: 1/2" TO 6"



SKU: 1477E90
SCH40 90DEG ELBOW
Size: 1/2" TO 6"



SKU: 1477E45
SCH40 45DEG ELBOW
Size: 1/2" TO 6"



SKU: 1477ET
SCH40 EQUAL TEE
Size: 1/2" TO 6"



SKU: 1477EC
SCH40 END CAP
Size: 1/2" TO 6"



SKU: 1477FE
SCH40 FAUCET ELBOW
Size: 1/2" TO 2"



SKU: 1477VS
SCH40 VALVE SOCKET
Size: 1/2" TO 4"



SKU: 1477VE15
SCH40 VALVE ELBOW
Size: 1/2"



SKU: 1477SP
SCH40 SCREW PLUG
Size: 1/2" TO 4"



SKU: 1477FT
SCH40 FAUCET TEE
Size: 1/2" TO 1"



SKU: 1477FS
SCH40 FAUCET SOCKET
Size: 1/2" TO 4"



SKU: 1477RS
SCH40 REDUCE SOCKET
Size: 3/4" x 1 1/2" TO 6" x 4"



SKU: 1477RT
SCH40 REDUCE TEE
Size: 3/4" x 1 1/2" TO 6" x 4"



SKU: 1477RB
SCH40 REDUCE BUSH
Size: 3/4" x 1/2" TO 2" x 1 1/2"



SKU: 1477TEN
PVC NIPPLE MXM
Size: 1/2" TO 4"



SKU: 1477TET
PVC FEMALE
EQUAL TEE FxFxF
Size: 1/2" TO 4"



SKU: 1477TRS
PVC FEMALE
REDUCING COUPLING
Size: 3/4" x 1/2" TO 1 1/2" x 1"



SKU: 1477TRT
PVC FEMALE
REDUCEING TEE
Size: 3/4" x 1/2" TO 2" x 1 1/2"



SKU: 1477TE90
PVC FEMALE ELBOW
Size: 1/2" TO 4"



SKU: 1477TES
PVC FEMALE
COUPLING FxF
Size : 1/2" TO 4"



SKU: 1477TRB
PVC REDUCER MxF
Size: 3/4" x 1/2" TO 4" x 3"



SKU: 1477TEN
PVC EQUAL NIPPLE
Size: 1/2" TO 4"



SKU: 1477TU
PVC FEMALE UNION
Size: 1/2" TO 2"



SKU: 1477TCF
PVC FLANGE ADAPTER
FxF
Size: 1/2" TO 2"

272 UPVC FITTING



SKU: 272CV
UPVC DRAINAGE NON-
RETURN VALVE

ERA® VALVES AND FITTINGS



SKU: BVAWEU
PVC TRUE UNION BALL VALVE
Size availability:
½" TO 4"



SKU: BVAWE / BVAWE_T
PVC COMPACT BALL VALVE [SOCKET / THREAD]
Size availability:
½" TO 4"



SKU: BTFVAWE
PVC BUTTERFLY VALVE
Size availability:
2" TO 8"



SKU: BTFVAWE
PVC [HAND WHEEL] BUTTERFLY VALVE
Size availability:
10" TO 12"



SKU: SCVAWE
PVC SWING CHECK VALVE
Size availability:
2½" TO 6"



SKU: CVAWE
PVC SPRING CHECK VALVE
Size availability:
½" TO 4"



SKU: BCVAWE
PVC BALL CHECK VALVE
Size availability:
½" TO 2"



SKU: FVAWE / FVAWE-T
PVC FOOT VALVE [SOCKET / THREAD]
Size availability:
½" TO 6"



SKU: FVAWE200
8" PVC FOOT VALVE [SOCKET / THREAD]



SKU: BVAWEU-MI
UPVC TRUE UNION BALL VALVE JISK SOCKET END X MALE BSP
Size availability:
½" TO 4"



SKU: CVAWEII
UPVC SPRING CHECK VALVE TYPE II C/W SOCKET END
Size availability:
½" TO 2"



SKU: BVSCH80CEU
CPVC TRUE UNION BALL VALVE
Size availability:
½" TO 4"



SKU: AWUE
UPVC UNION C/W JIS "SOCKET END"
Size availability:
½" TO 6"



SKU: AWUE-MI
UPVC MALE UNION C/W JIS "SOCKET END & MALE THREAD" COLOUR GREY
Size availability:
1½" TO 2"



SKU: AWFLSE
AW JIS FLANGE
Size availability:
½" TO 4"



SKU: AWSJE
AW JIS K6743 SIMPLE JOINT TPS NETT
Size availability:
½" TO 4"



SKU: CVAWSUE
PVC SINGLE UNION SPRING CHECK VALVE
Size availability:
½" TO 2"



SKU: WCVAWUE
PVC WAFER CHECK VALVE
Size availability:
3" TO 12"



SKU: AWKCN
AW THREADED KC NIPPLE
Size availability:
½" TO 2"

213 UPVC FITTING



SKU: 213B90-E
"ERA" 88DEG BEND(FXF)
Size: 1¼"-2"



SKU: 213LI-MF
"ERA" UPVC LEVEL INVERT TAPER MXF
Size: 2"X1½"-6"X4"



SKU: 213PF
"ERA" UPVC PUDDLE FLANGE
Size: 1½" TO 4"



SKU: 213FS
"ERA" FEMALE IRON CONNECTOR
Size: 1½", 2"



SKU: 213AC-MF
"ERA" ACCESS CAP & PLUG (CLEAN OUT)
Size: 2"-8"



SKU: 213VS-P
"ERA" AUD024 "FITTING" MALE IRON CONNECTOR
Size: 1½", 2"



SKU: 213VC
"ERA" VENT COWL
Size: 2"-4"



SKU: 213RB
"ERA" UPVC REDUCE BUSH
Size:
42x35-150x100mm



SKU: 213POC
"ERA" UPVC PUSH ON CAP
Size: 1¼" TO 6"



SKU: 213VS
"ERA" AUD025 MALE IRON CONNECTOR
Size: 1½", 2"



SKU: 213B90040N
42mm "NORIKA" UPVC 88DEG BEND



ERA[®] PP-R PIPE & FITTINGS

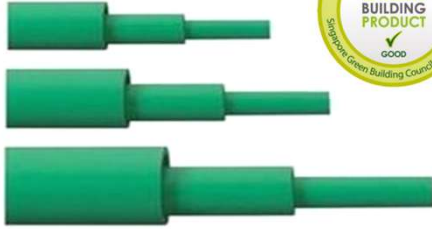

PP-R PIPE
COUNTRY OF ORIGINAL: CHINA
STANDARD: PN10(COLD), PN20(HOT)
Size availability (MM):
20,25,32,40,50,63,75,90,110



PP-R WELDING MACHINE
Size availability(MM):
20 -32,20-63,75-110



SKU: PPRES
PPR EQUAL SOCKET
Size availability(mm):
20-110



SKU: PPRE90
PPR 90DEG ELBOW
Size availability(mm):
20-110



SKU: PPRE45
PPR 45DEG ELBOW
Size availability(mm):
20-110



SKU: PPRET
PPR EQUAL TEE
Size availability(mm):
20-110



SKU: PPREC
PPR END CAP
Size availability(mm):
20-110



SKU: PPRRS
PPR REDUCING SOCKET
Size availability(mm):
25X20 ~ 110X90



SKU: PPRMIS
PPR MI SOCKET
Size availability(mm):
20X15 TO 63X50



SKU: PPRMIE
PPR MI ELBOW
Size availability(mm):
20X15 TO 32X25



SKU: PPRMIT
PPR MI TEE
Size availability(mm):
20X15 TO 32X25



SKU: PPRFIS
PPR FI SOCKET
Size availability(mm):
20X15 TO 63X50



SKU: PPRFIE
PPR FI ELBOW
Size availability(mm):
20X15 TO 32X25



SKU: PPRU
PPR UNION
Size availability(mm):
20 - 63



SKU: PPRFIT
PPR FI TEE
Size availability(mm):
20X15 TO 32X25
40X32



SKU: PPRCJ
PPR COMBINING JOINT
Size availability(mm):
20-32



SKU: PPRSV-CP
PPR STOP VALVE WITH CHROME HANDLE
Size availability(mm):
20-32



SKU: PPRSV
PPR STOP VALVE
Size availability(mm):
20-110



SKU: PPRBV
PPR TRUE UNION BALL VALVE
Size availability(mm):
20-63



SKU: PPRSCB
PPR CROSS BEND
Size availability(mm):
20-32



SKU: PPRUC
PPR U-PIPE TRACKET (LOWER TYPE)
Size availability(mm):
20-50



SKU: PPRUC-H
PPR U-PIPE TRACKET
Size availability(mm):
20-63



SKU: PPRRS711
PPR REPAIR STICK
Size availability(mm):
7X11



SKU: PPRRST711
PPR REPAIR STICK TOOL
Size availability(mm):
7X11



SKU: PPRFE02015S
PPR DOUBLE FEMALE THREAD ELBOW IN SET PPR
Size: Ø20MMx1/2"



SKU: PPRFT02015S
PPR DOUBLE FEMALE THREAD TEE
Size: Ø20MMx1/2"



SKU: PPRFE02015
PPR FI ELBOW WITH BRACKET
Size availability(mm):
20MMx1/2"



SKU: PPRFLS
PPR FLANGE SOCKET
Size availability(mm):
40-110



SKU: PPRRT
PPR REDUCING TEE
Size availability(mm):
25x20-110x90

ERA[®] SCH80 PIPE & FITTINGS



5.8M "ERA" UPVC SCH80 ASTM D1785 PIPE,
& UPVC SCH80 ASTM D2467 FITTINGS
COUNTRY OF ORIGINAL:CHINA

Size availability (MM):
15, 20, 25, 35, 42, 50, 65, 80, 100, 125, 150, 200



SKU: SCH80ES
SCH80 EQUAL SOCKET
Size availability(mm):
15-150



SKU: SCH80E90
SCH80 90DEG ELBOW
Size availability(mm):
15-150



SKU: SCH80E45
SCH80 45DEG ELBOW
Size availability(mm):
15-150



SKU: SCH80ET
SCH80 EQUAL TEE
Size availability(mm):
15-150



SKU: SCH80EC
SCH80 END CAP
Size availability(mm):
15-150



SKU: SCH80FE
SCH80 FI ELBOW
Size availability(mm):
15-50



SKU: SCH80FT
SCH80 FI TEE
Size availability(mm):
15-25



SKU: SCH80RS
SCH80 REDUCING
COUPLING
Size availability(mm):
20X15 TO 50X42



SKU: SCH80RB
SCH80 REDUCING
RING
Size availability(mm):
20X15 TO 150X100



SKU: SCH80FS
SCH80 FI ADAPTOR
Size availability(mm):
15-150



SKU: SCH80VS
SCH80 MI ADAPTOR
Size availability(mm):
15-100



SKU: SCH80RT
SCH80 REDUCING TEE
Size availability(mm):
20X15 TO 50X42



SKU: SCH80EN
SCH80 NIPPLE
Size availability(mm):
15-100



SKU: SCH80CT
SCH80 CROSS TEE
Size availability(mm):
15-50



SKU: SCH80VSF
SCH80 VAN STONE FLANGE
Size availability(mm):
50-300

ERA[®] SCH80C PIPE & FITTINGS



5.8M "ERA" CPVC SCH80 ASTM F-441 PIPE,
& CPVC SCH80 ASTM F-439 FITTINGS

COUNTRY OF ORIGINAL: CHINA

Size availability (MM):

15, 20, 25, 35, 42, 50, 65, 80, 100, 125, 150, 200



SKU: SCH80CES
CPVC SCH80 EQUAL
SOCKET
Size availability(mm):
15-100



SKU: SCH80CE90
CPVC SCH80 90DEG
ELBOW
Size availability(mm):
15-10



SKU: SCH80CE45
CPVC SCH80 45DEG
ELBOW
Size availability(mm):
15-100



SKU: SCH80CET
CPVC SCH80 EQUAL TEE
Size availability(mm):
15-100



SKU: SCH80CEC
CPVC SCH80 END
CAP
Size availability(mm):
15-100



SKU: SCH80CFE
CPVC SCH80 FI ELBOW
Size availability(mm):
15-50



SKU: SCH80CFT
CPVC SCH80 FI TEE
Size availability(mm):
15-25



SKU: SCH80CRS
CPVC SCH80
REDUCING
COUPLING
Size availability(mm):
20X15 TO 50X42



SKU: SCH80CRB
CPVC SCH80
REDUCING RING
Size availability(mm):
20X15 TO 150X100



SKU: SCH80CFS
CPVC SCH80 FI
ADAPTOR
Size availability(mm):
15-150



SKU: SCH80CVS
CPVC SCH80 MI
ADAPTOR
Size availability(mm):
15-100



SKU: SCH80CRT
CPVC SCH80
REDUCING TEE
Size availability(mm):
20X15 TO 50X42



SKU: SCH80CCT
CPVC SCH80 CROSS TEE
Size availability(mm):
15-50



SKU: SCH80CVSF
CPVC SCH80 VAN
STONE FLANGE
Size availability(mm):
50-300



SKU: SCH80CFLS
CPVC SCH80 TS FLANGE
Size availability(mm):
15-100



AW(VP) PVC PIPE RWDP(AEO) PVC PIPE

STANDARD: JIS K6741:2007
COUNTRY OF ORIGINAL: MALAYSIA
Size availability: 15MM TO 450MM

SEKISUI

AW FITTING MADE IN JAPAN

AW FITTING STANDARD: JIS K6743:2007



SKU: AWES
AW EQUAL SOCKET
Size availability:
13MM TO 300MM



SKU: AWE90
AW 90DEG ELBOW
Size availability:
13MM TO 300MM



SKU: AWE45
AW 45DEG ELBOW
Size availability:
13MM TO 300MM



SKU: AWET / AWRT
AW EQUAL TEE/
REDUCE TEE
Size availability:
13MM TO 300MM



SKU: AWEC
AW END CAP
Size availability:
13MM TO 150MM



SKU: AWRS
AW REDUCE SOCKET
Size availability(MM):
15X13 TO 300X200



SKU: AWVS
AW VALVE SOCKET
Size availability:
13MM TO 150MM



SKU: AWFS
AW FAUCET
SOCKET
Size availability:
13MM TO 80MM



SKU: AWFT
AW FAUCET TEE
Size availability:
13MM TO 25MM



SKU: AWFE
AW FAUCET ELBOW
Size availability:
13MM TO 25MM



SKU: AWFLS
AW FLANGE SOCKET
10K
Size availability(MM):
15 TO 300



SKU: AWRB
AW REDUCING BUSH

OTHER LIANGE CHEW HARDWARE PRODUCTS



SKU: EPCM88
HERME - SEAL NO.88



SKU: AWTC-S
AW TANK CONNECTOR
SOCKET END FOR PIPE
Size availability:
1/2" TO 2"



AE(VU) PVC PIPE RWDP(AEO) PVC PIPE

STANDARD: JIS K6741:2007
COUNTRY OF ORIGINAL: MALAYSIA
Size availability: 15MM TO 450MM

SEKISUI

AE FITTING MADE IN JAPAN

AE FITTING STANDARD: JIS K6739:2007



SKU: AEES
AE EQUAL SOCKET
Size availability:
42MM TO 400MM



SKU: AEE90
AE 90DEG ELBOW
Size availability:
30MM TO 400MM



SKU: AEE45
AE 45DEG ELBOW
Size availability:
30MM TO 400MM



SKU: AEET / AERT
AE EQUAL TEE/
REDUCE TEE
Size availability:
42MM TO 400MM



SKU: AERS
AE REDUCE SOCKET
Size availability(MM):
15X13 TO 300X200



SKU: AEYT
AE Y TEE
Size availability:
42MM TO 200MM



SKU: AECC
AE CAP
Size availability:
42MM TO 300MM



SKU: AESC
AE SCREW CAP
Size availability:
25MM TO 250MM



SKU: AERB
AE REDUCING BUSH



SKU: SCS500
ESLON ADHESIVE
NO.70P 500G/TIN



SKU: PIPCPJ
CLEAR TRANSPARENCY
PVC PIPE (4M LONG)
Size: 13 ~ 200mm

RIDGID TOOLS & MACHINES



SKU: PFMR15025N
RP 218 PRESS TOOL



SKU: PFMR15050N
RP 318
PRESS TOOL
Capacity: 1/2" to 2" for
copper and stainless steel,
1/2" to 2" for PEX



SKU: PFMR65100
RP 380
PRESS TOOL
Capacity: 2 1/2" to 4" for
copper and stainless steel.



SKU: RID59138
POWERCLEAR™
MACHINE
For 3/4" to 1 1/2"
Drain Lines



SKU: RID50557
1450 PRESSURE
TEST PUMP



SKU: RID46683
K-1 COMBINATION
AUGER



SKU: RID57003
EZ CHANGE FAUCET
TOOL



SKU: RID42478
STRAP LOCK PIPE
HANDLE
Fits all sizes of plastic pipe
between 3" and 8" diameter



SKU: RID29983/ RID29993
INNER-OUTER REAMER
Capacity:
6-40MM & 12-50MM



SKU: RID32573
2-IN-1 CLOSE
QUARTERS
AUTOFEED CUTTER
Size: 6 – 28 MM



SKU: RID31642
QUICK-ACTING
TUBING CUTTERS
(for copper tube)



SKU: RID30088
RATCHET CUTTERS
WITH ERGONOMIC
GRIPS



SKU: RID31803
STAINLESS STEEL
TUBING CUTTERS
Capacity:
6 - 67 MM



SKU: RID41608 /RID40868
PTEC PLASTIC DRAIN
PIPE CUTTERS



SKU: RID23488
SINGLE STROKE
CUTTERS
Capacity:
3 - 42 MM



SKU: RID57008 / RID57013
C-STYLE CLOSE
QUARTERS COPPER
TUBING CUTTERS
Size: 1/2"-3/4" & 1"



SKU: RID68962
SUPERFREEZE PIPE
FREEZING UNIT
(SF-2500)

MATING FLANGE DIMENSIONS

	PN 6		PN 10		PN 16		PN25		JIS 5K		JIS 10K	
DN	PCD of holes	Number of holes	PCD of holes	Number of holes	PCD of holes	Number of holes	PCD of holes	Number of holes	PCD of holes	Number of holes	PCD of holes	Number of holes
25	75	4 x 11.5	= PN 16		85	4 x 14	85	4 x 14	75	4 x 11.5	90	4 x 18
32	90	4 x 14			100	4 x 18	100	4 x 18	90	4 x 14	100	4 x 18
40	100	4 x 14			110	4 x 18	110	4 x 18	95	4 x 14	105	4 x 18
50	110	4 x 14			125	4 x 18	125	4 x 18	105	4 x 14	120	4 x 18
65	130	4 x 14			145	4 x 18	145	8 x 18	130	4 x 14	140	4 x 18
80	150	4 x 18			160	8 x 18	160	8 x 18	145	4 x 18	150	8 x 18
100	170	4 x 18			180	8 x 18	190	8 x 23	165	8 x 18	175	8 x 18
125	200	8 x 18			210	8 x 18	220	8 x 26	200	8 x 18	210	8 x 23
150	225	8 x 18			240	8 x 23	250	8 x 26	230	8 x 18	240	8 x 23
175	-	-			270	8 x 23	270	8 x 23	280	8 x 26	-	-
200	280	8 x 18	295	8 x 23	295	12 x 23	310	12 x 26	280	8 x 23	290	12 x 23
250	335	12 x 18	350	12 x 23	355	12 x 27	370	12 x 30	345	12 x 23	355	12 x 25
300	395	12 x 23	400	12 x 23	410	12 x 27	430	16 x 30	390	12 x 23	400	16 x 25
350	445	12 x 23	460	16 x 23	470	16 x 27	490	16 x 33	435	12 x 25	445	16 x 25
400	495	16 x 23	515	16 x 27	525	16 x 30	550	16 x 36	495	16 x 25	510	16 x 27
450	-	-	565	20 x 27	585	20 x 30	600	20 x 36	555	16 x 25	565	20 x 27
500	600	20 x 23	620	20 x 27	650	20 x 33	660	20 x 36	605	20 x 25	620	20 x 27
550	-	-	-	-	-	-	-	-	665	20 x 27	680	20 x 33
600	705	20 x 27	725	20 x 30	770	20 x 36	770	20 x 39	715	20 x 27	730	20 x 33
700	810	24 x 27	840	24 x 30	840	24 x 36	875	24 x 42	820	24 x 27	840	24 x 33
800	920	24 x 30	950	24 x 33	950	24 x 39	990	24 x 48	930	24 x 33	950	28 x 33
900	1020	24 x 30	1050	28 x 33	1050	28 x 39	1090	28 x 48	1030	24 x 33	1050	28 x 33
1000	1120	28 x 30	1160	28 x 36	1170	28 x 42	1210	28 x 55	1130	28 x 33	1160	28 x 39
(1100)	-	-	1270	28 x 36	1280	28 x 42	1315	28 x 55	1240	28 x 33	1270	28 x 39
1200	1340	32 x 33	1380	32 x 49	1390	32 x 49	1420	32 x 55	1350	32 x 33	1380	32 x 39

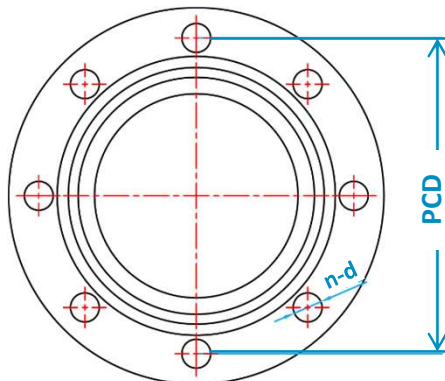

PIPE'S DIMENSIONS SUMMARY

	JIS 6741:1984 VP/AW		JIS 6741:1984 VP/AE		AEO		SS213:1983 BSS5255 BS4514 AS1260 SS272:1983 BS4660 BSS481 AS1260		SCH40		AS/NZS1477		SS141:1976		SCH80 ASTM D1785			
Size	OD	ID	OD	ID	OD	ID	OD	ID	CLASS	OD	ID	CLASS	OD	CLASS	OD	CLASS	OD	ID
mm	mm	mm	mm	mm	mm	mm	mm	mm		mm	mm		mm		mm		mm	mm
13	17.8	13.4	17.8	14.2	17.8	14.2												
15	22.0	16.6	22.0	18.4	22.0	18.4			E/White	21.2	17.8	E/White	21.7	E/White	21.3	D/Grey	21.3	13.9
20	25.8	20.4	25.8	22.2	25.8	22.2			E/White	26.6	22.8	E/White	27.2	E/White	26.7	D/Grey	26.7	18.8
25	31.8	25.6	31.8	28.2	31.8	28.2			E/White	33.4	29.0	E/White	34.0	E/White	33.4	D/Grey	33.4	24.3
35	37.8	31.6	37.8	34.2	37.8	34.2	36.2	32.0	E/White	42.1	36.7	E/White	42.7	E/White	42.2	D/Grey	42.2	32.5
42	47.8	40.6	47.8	44.2	47.8	44.8	42.8	38.2	D/White	48.1	43.1	D/White	48.7	D/White	48.3	D/Grey	48.3	38.1
50	60.0	51.8	60.0	56.4	60.0	57.0	55.7	50.9	D/White	60.0	53.8	D/White	60.8	D/White	60.3	D/Grey	60.3	49.3
65	75.0	66.8	75.0	70.6	75.0	71.0	68.7	63.3	D/White	73.0	67.2	D/White	75.8	D/White	75.0	D/Grey	73.0	59.0
75	88.7	77.7	88.7	83.3	88.7	84.7	82.3	76.3	D/White	88.9	79.5	D/White	89.4	D/White	88.9	D/Grey	88.9	73.7
100	114.0	100.8	114.0	107.8	114.0	109.6	110.0	103.6	D/White	114.0	102.0	D/White	115.0	D/White	114.3	D/Grey	114.3	97.2
125	139.2	125.2	139.2	131.0	139.2	134.8			D/White	141.0	125.4	D/White	141.3	D/White	140.0	D/Grey	141.3	122.3
150	164.5	146.7	164.5	154.3	164.5	159.5	160.0	152.0	D/White	168.0	150.4	D/White	161.0	D/White	168.3	D/Grey	168.3	146.3
200	215.3	194.7	215.3	202.3	215.3	207.3	200.0	192.0	B/Grey	219.8	202.8	B/Grey		B/Grey	218.8	D/Grey	219.1	193.7
250	266.1	240.7	266.1	250.5	266.1	258.1	250.0	237.8	B/Grey	273.6	259.4	B/Grey		B/Grey	272.6	D/Grey	273.1	242.9
300	317.0	286.8	317.0	298.6	317.0	306.0	315.0	299.6	B/Grey	323.4	307.8	B/Grey		B/Grey	323.4	D/Grey	323.9	289.0
350	370.0	334.0	370.0	352.0														
400	420.0	379.0	420.0	400.0														

OD: Outside Diameter

ID: Inside Diameter

PIPE'S DIMENSIONS SUMMARY

	BSEN1057 TABLE X		BSEN1057 TABLE Y		BS1387 GI A		BS1387 GI B		BS1387 GI C			PPR PN10 (Cold)		PPR PN20 (Hot)		Ductile Iron Pipe BSEN545 K=9		Hubless Pipe ASTM C564:1995					
Size mm	OD mm	ID Mm	OD mm	ID mm	OD mm	ID mm	OD mm	ID mm	OD mm	ID mm		Size mm	OD mm	ID Mm	OD mm	ID mm	OD mm	ID mm	OD mm	ID mm			
13					17.10	13.50	17.40	12.72															
15	15.05	13.65	15.05	13.45	21.40	17.40	21.70	16.42	21.70	15.20													
20	22.06	20.26	22.06	20.06	26.90	22.20	27.20	21.92	27.20	20.70			20.0	15.4	20.0	13.2							
25	28.06	26.28	28.06	25.65	33.70	28.40	34.20	27.70	34.20	26.08			25.0	19.4	25.0	16.6							
35	35.07	32.67	35.07	32.07	42.40	37.10	42.80	36.30	42.80	34.68			35	32.0	24.8	32.0	21.2						
42	42.07	39.67	42.07	39.07	48.30	42.50	48.70	42.20	48.70	40.58			40	40.0	31.0	40.0	26.6						
50	54.07	51.67	54.07	51.07	60.20	54.40	60.80	53.48	60.80	51.86			50	50.0	38.8	50.0	33.4			69.59	50.80		
65	66.75	64.35	66.75	62.75	76.00	69.50	76.60	69.28	76.60	67.66			63	63.0	48.8	63.0	42.0						
75	76.30	73.30	76.30	72.30	88.70	82.20	89.50	81.38	89.50	79.74			75	75.0	61.4	75.0	61.4	98.0	74.0	85.09	76.21		
100	108.25	105.25	108.25	104.25	113.80	106.50	114.90	105.96	114.90	104.14			90	90.0	73.6	90.0	73.6	118.0	93.9	111.25	101.60		
125													110	110.0	90.0	110.0	90.0						
150	159.50	155.50					140.60	130.84	140.60	129.84			150										
200							165.10	155.34	166.10	155.34			200							170.0	143.7	160.02	150.88
250							216.30	204.70					250							222.0	193.6	212.85	201.68
300							267.40	254.20					300							274.0	243.2		
350							318.50	304.70					350							326.0	292.8		
400							355.60	339.80					400							378.0	342.3		
							406.40	390.60												429.0	391.9		

OD: Outside Diameter

ID: Inside Diameter

CONVERSION TABLE

M METRIC STRAIGHT THREAD					
Thread size	Pitch	Thread Diameter On Base Plane			Thread Angle
		Major Dia	Pitch Dia	Minor Dia	
M6	1	6	5.350	4.917	60
M8	1.25	8	7.188	6.647	
M10	1.5	10	9.026	8.376	
M12	1.75	12	10.863	10.106	
M14	2	14	12.701	11.835	
M16	2	16	14.701	13.835	
M18	2.5	18	16.376	15.294	
M20	2.5	20	18.376	17.294	
M22	2.5	22	20.376	19.294	
M24	3	24	22.051	20.752	
M27	3	27	25.051	23.752	
M30	3.5	30	27.727	26.211	
M33	3.5	33	30.727	29.211	
M36	4	36	33.402	31.670	
M39	4	39	36.402	34.670	
M42	4.5	42	39.077	37.129	
M45	4.5	45	42.077	40.129	
M48	5	48	44.752	42.587	
M52	5	52	48.752	46.587	
M56	5.5	55	52.428	50.046	
M60	5.5	60	56.428	54.046	
M64	6	64	60.103	57.505	
M68	6	68	64.103	61.505	
M70	6	70	66.103	63.505	
M72	6	72	68.103	65.505	
M76	6	76	72.103	69.505	
M80	6	80	76.103	73.505	
M85	6	85	81.103	78.505	
M90	6	90	86.103	83.505	
M95	6	95	91.103	88.505	
M100	6	100	96.103	93.505	
M115	6	115	111.103	108.505	
M150	8	150	144.804	141.340	
M160	8	160	154.804	151.340	

BSP/ R/ R1/ Rc/ ZG/ RT/ PT/ BSPT					
Thread size (inch)	Teeth/ inch	Thread Diameter On Base Plane			Thread Angle
		Major Dia	Pitch Dia	Minor Dia	
1/16	28	7.723	7.142	6.561	55
1/8	28	9.728	9.147	8.566	
1/4	19	13.157	12.301	11.445	
3/8	19	16.662	15.806	14.950	
1/2	14	20.995	19.793	18.631	
5/8	14	22.911	21.749	20.587	
3/4	14	26.441	25.279	24.117	
7/8	14	30.201	29.059	27.877	
1	11	33.249	31.770	30.291	
1-1/8	11	37.897	36.418	34.939	
1-1/4	11	41.910	40.431	38.952	
1-1/2	11	47.803	46.324	44.845	
1-3/4	11	53.746	52.267	50.788	
2	11	59.614	58.135	56.656	
2-1/2	11	75.184	73.705	72.226	
3	11	87.884	86.405	84.926	
4	11	113.03	111.550	110.072	
6	11	163.83	162.351	160.872	

BSW					
Thread size (inch)	Teeth/ inch	Thread Diameter On Base Plane			Thread Angle
		Major Dia	Pitch Dia	Minor Dia	
1/16	60	1.587	1.315	1.050	55
1/8	40	3.175	2.768	2.362	
1/4	20	6.350	5.537	4.724	
3/8	16	9.525	8.509	7.492	
1/2	12	12.700	11.345	9.990	
5/8	11	15.876	14.397	12.918	
3/4	10	19.051	17.424	15.798	
7/8	9	22.226	20.419	18.611	
1	8	25.400	23.368	21.335	
1-1/8	7	28.576	26.253	23.929	
1-1/4	7	31.751	29.428	27.104	
1-1/2	6	38.100	35.391	32.680	
1-3/4	5	44.452	41.199	37.946	
2	4 1/2	50.802	47.187	43.573	
2-1/2	4	63.502	59.436	55.370	
3	3 1/2	76.203	71.556	66.909	
4	3	101.604	96.182	90.76	
6	2 1/2	152.406	145.900	139.394	

LINEAR MEASURE					
Km	m	cm	mm	inch	Ft
1	10 ³	10 ⁵	10 ⁶	39370	3280.83
0.001	1	100	1000	39.37	3.28083
10 ⁻⁵	0.01	1	10	0.3937	0.032808
10 ⁻⁶	0.001	0.1	1	0.03937	0.003281
2.54x10 ⁻⁵	0.0254	2.540	25.40	1	0.08333
0.384x10 ⁻⁴	0.3048	30.480	304.801	12	1

INCH AND MILLIMETER COMPARISON TABLE						
INCH	1/8"	1/4"	3/8"	1/2"	3/4"	1"
MM	3.175	6.350	9.525	12.700	19.050	25.400
DN	6	8	10	15	20	25
	1分	2分	3分	4分	6分	8分

PRESSURE CONVERSION				
Kpa	Pa	PSI	Bar	Kgf/ cm ²
1	10 ³	0.14503774	0.01	0.010197162
0.001	1	0.000145	0.00001	0.0000102
6.894757	6894.757	1	0.0689476	0.070307
100	10 ⁵	14.5037744	1	1.0197162
98.0665	98066.5	14.2233439	0.980665	1

TEMPERATURE CONVERSION	
Centigrade (°C)	Fahrenheit Degree (°F)
1	33.8
-17.222222	1
C= (F-32) ÷ 1.8	F= C × 1.8 + 32

TABLES OF EQUIVALENTS

PRESSURE

lbs per sq. in.	Feet of Water	Inches of Mercury	Atmospheres	Millibars	Metres of Water	Kn per cm ²	Millimetres of Mercury	Kn per m ²
Psi	ft H ₂ O	In Hg	atm	mbar	mH ₂ O	KN/cm ²	mmHg	KN/m ²
1	2.309	2.036	0.068	70.37	0.703	0.07	51.71	6.895
0.434	1	0.883	0.029	30.48	0.305	0.03	22.42	2.935
0.491	1.133	1	0.033	34.52	0.345	0.034	25.4	3.386
14.70	33.9	29.92	1	1033	10.33	1.033	700	101.4
0.014	0.033	0.029	0.001	1	0.01	0.001	0.735	0.098
1.422	3.281	2.895	0.097	100	1	0.100	73.55	9.808
14.22	32.81	28.96	0.968	1000	10	1	735.5	98.50
0.019	0.045	0.039	0.001	1.36	0.013	0.001	1	0.133
0.145	0.335	2.953	0.010	10.21	0.102	0.010	7.500	1

RATE OF FLOW

G.p.m.	G.p.h.	Cu. Ft. p.h.	Tons p.h.	Litres p.m.	Litres p.h.	US galls p.m.	US galls p.h.	M ³ p.h.
UK Gal/min	UK Gal/hr	Cu ft/hr	Ton/hr	L/min	L/hr	US Gal/min	US Gal/hr	M ³ /hr
1	60	9.63	0.268	4.54	272.7	1.2	72	0.273
0.016	1	0.16	0.004	0.076	4.54	0.02	1.2	0.005
0.104	6.23	1	0.027	0.472	28.32	0.125	7.48	0.028
3.73	224	36	1	16.99	1019.2	4.41	264.6	1.019
0.22	13.19	2.118	0.06	1	60	0.26	15.6	0.060
0.004	0.22	0.035	0.001	0.016	1	0.004	0.28	0.001
0.833	49.98	8.02	0.22	3.79	227.4	1	60	0.227
0.014	0.833	0.13	0.036	0.063	3.79	0.016	1	0.004
3667	220.3	35.312	0.981	16.667	1000	4.398	263.9	1

Pressfitting Profiles “M” and “V”

In plumbing applications, one of the most asked questions is whether to choose between “M” or “V” press fitting profiles.

The first press was developed in 1950’s, and was patented in 1962 and was developed by Mannesman GmbH thus calling it the “M” profile. Many years later, in 1989, the “V” profile was developed and released in the market by Viega LLC.

The most visible between the two profiles will come down to that the “V” profile is the “collar” situated after the O-ring seat, while on the other hand the “M” profile does not have any “collar”. Please refer to the diagram below.

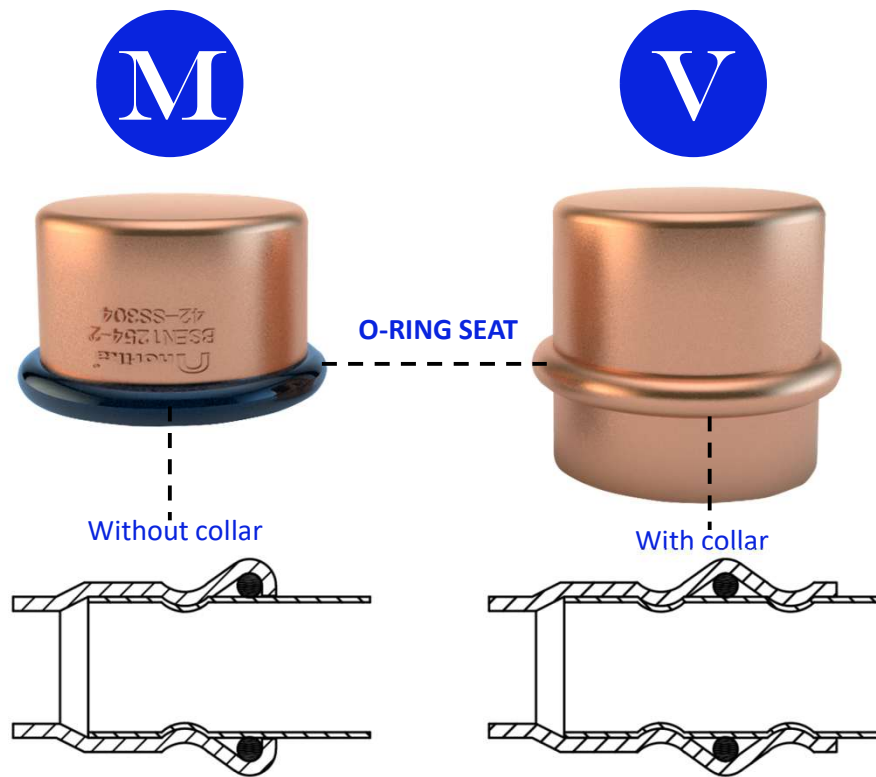

Both profiles use the same pressing equipment, although there is quite a difference in their jaws. Further investigation suggest that V press fittings have “stalk” located immediately after the pressing chamber, making the pipe insertion process better if compared to the M profile. But at the same time, the presence of stalk makes it quite difficult to check the proper positioning of the o-ring.

In terms of general performance of the fittings, we can refer to the recommendation of the manufacturers of both the fittings and tooling. Gathering all of the available information and referring to manufacturer recommendations, the below chart was developed.

Maximum Working Pressure for potable water at ambient temperature (kpa)			
Size	"M" Profile		"V" Profile
	Standard	HP	
15mm	4000	N/A	1600
22mm	4000	N/A	1600
28mm	2500	4000	1600
35mm	2500	4000	1600
42mm	2500	4000	1600
54mm	2500	4000	1600
76.1mm	1600	2500	N/A
88.9mm	1600	2500	N/A
108mm	1600	2500	N/A
168.3mm	1600/2000*	N/A	N/A

*Note: "Standard & HP" refer to jaw types; "V" Profile maximum working pressures taken from technical catalogues of Viega & Connex Banninger; *168.3mm pressures differ depending on single pressing or double off-set pressing.*

Based on the informations given, if you are looking for the maximum safety in any installations, "M" Profile fittings pressed using the appropriately rated tool (minimum 32 kN) and the relevant HP Jaws should be used.

In general circumstances, the choice is made on the basis of preference of the installer. Both profiles must comply with the same regulations and have the same certifications. There is no difference in functionality. Fluids pass through the fittings and pipes in the same manner. On the technical level, it can be described that the most visible difference between them is the presence of collar for the V Profile, whereas M Profile press fittings does not have any "collar".

Self Collection

#01-38/48

10 Admiralty Street
Northlink Building
#02-45
Singapore 757695
Tel: (65) 62960224

For product orders through
Whatsapp

(65) 9642 2351
(65) 9137 1409

**Project-Singapore
Building and construction**

(65) 9725 3074

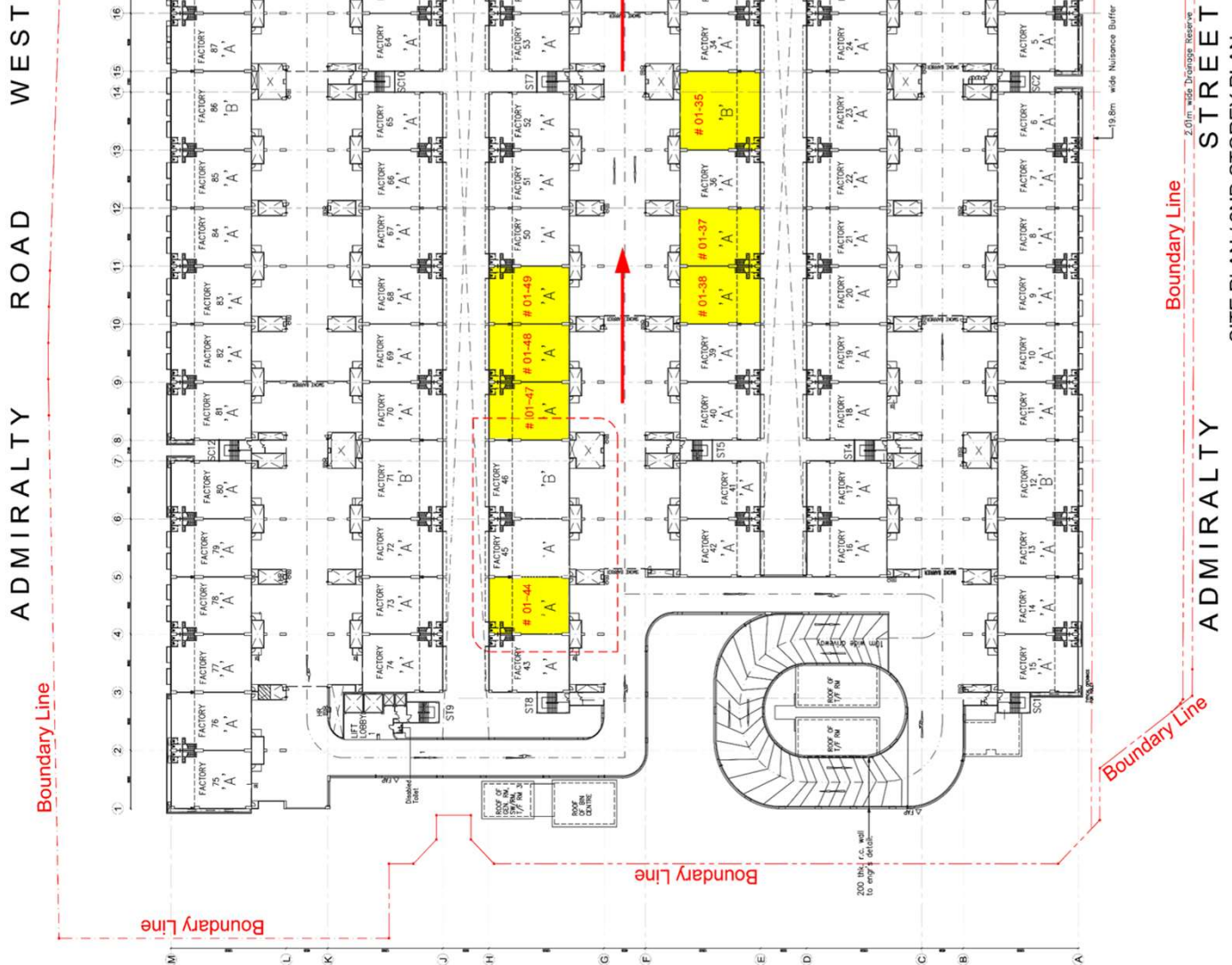

ADMIRALTY ROAD WEST
ADMIRALTY STREET
SITE PLAN / 2ND STOREY PLAN
SCALE 1:250