

PRESS CONNECTION TOOLS

RP 318 PRESS TOOL

SKU:PFMR15050N



SPECIFICATIONS:

- Crimp pipe diameter 15-50mm
- 270° Rotate the jaws.
- Output pressure: 32kN
- Weight Without Battery: 3.3 kg. Operating Temperature: -10 °C to +50 °C
- Single crimping time: 7 seconds
- Long service life. It will be reminded after 30,000 crimps and the tool will lock after 32,000 crimps.
- Standard Battery: 18V 2.0Ah Lithium Battery
- Standard Battery Charger: 230V
- The LED display will flash, indicating that the temperature range is exceeded, the battery is low, or maintenance is required.
- Compatible with standard series crimping jaws of RIDGID and other manufactures.
- suitable for copper pipes, steel pipes, stainless steel pipes, PEX and composite pipes.

Components List of RP318 Set

No	SKU	Description	Quantity	Weight (kg)/pc
1	PFMRA-59678	RP318 Pressing Tool	1	3.3
2	PFMRA-67583	15mm Pressing Jaw	1	1.80
3	PFMRA-67588	20mm Pressing Jaw	1	1.86
4	PFMRA-67593	25mm Pressing Jaw	1	1.96
5	PFMRA-67598	35mm Pressing Jaw	1	2.07
6	PFMRA-77723	42mm Swivel Ring	1	1.37
7	PFMRA-77728	54mm Swivel Ring	1	1.15
8	PFMRA-70168	Swivel Ring Actuator	1	1.85
9	PFMRA-56513	Batteries	2	0.47
10	PFMRA-43333	Battery Charger	1	0.86
11	-	Sling	1	-
12	RID29993	Reamer (1/2" to 2")	1	0.56
13	RID31803	Tubing Cutter	1	0.68

RIDGID



WARNING

ONLY USE TESTED AND APPROVED JAWS AND /OR ATTACHMENTS FOR RIDGID PRESS TOOL.

PRESSING JAW PATENT



APPROVED PRESSING JAWS IN SINGAPORE



RP 318 JAW



RP 380 JAW



RP 218 JAW

THESE PRESSING JAWS ARE ACCEPTED FOR MASS PRODUCTION AND DISTRIBUTION TO THE MARKET.

SAFETY REMINDER

USE OF INCORRECT PRESS TOOLS AND/OR ATTACHMENTS CAN CAUSE SYSTEM LEAKS, DAMAGE THE PRESS TOOLS AND ATTACHMENTS OR CAUSE SEVERE PERSONAL INJURY.



压接工具



⚠ 警告!

在使用工具前请仔细阅读本操作手册。如果未能理解或遵循手册中的内容进行操作，可能导致电击、火灾和/或严重人身伤害。

如果对里奇产品或服务有任何疑问 请联系:

- 艾默生精密工具技术(上海)有限公司
- 客户咨询: 400-820-5695
- 网址: www.RIDGID.cn

目录

机器序列号记录表.....2

安全标识符号.....3

基本安全规范

 工作区域安全.....3

 电气安全.....3

 个人安全.....4

 电动工具的使用和维护.....4

 电池工具的使用和维护.....4

 服务.....4

其它安全须知

 压接工具安全.....5

产品概述、规格和标准设备

 概述.....5

 规格.....5

 标准设备.....6

工具完好性检查.....6

工具组装和工作区域检查.....7

操作指南

 压接前的准备工作.....8

 使用典型的剪式压接钳对管件进行压接.....8

 使用典型的转换压接钳和压接环组件进行管件压接.....9

 检查压接情况.....10

维护指南

 清洁和润滑.....10

 需要RIDGID授权维修中心提供的维修服务.....10

附件.....10

存放.....10

维修与服务.....11

机器处置.....11

故障诊断.....12

RP318 诊断代码.....13

工具保证.....14

压接工具



RP318 压接工具	
在下方记下序列号并妥善保管铭牌上的产品序列号。	
序列号	

安全标识符号

在本操作手册和该产品上，利用了一些安全标识符号和专业词汇来表达重要的安全注意事项和安全规范。本节内容主要是帮助读者能更好地理解这些标识符号和用语。

 这是安全警告符号-用于对一些潜在的人身伤害危险进行警示。必须遵守安全信息的指导来规避可能的伤害事故发生，甚至死亡。

 **DANGER** 危险警告符号-表示一些存在危险情况的环境，如果不能避免，将导致死亡和严重的伤害事故。

 **WARNING** 警告符号-表示危险的境况，如果不能避免，也可能导致死亡或严重的伤害事故。

 **CAUTION** 小心符号-表示危险的境况，如果不能避免，可能导致轻微或中等程度伤害事故。

 **NOTICE** 注意符号-表示和保护财产相关的安全信息。

 该符号意味着使用者在使用该工具前必须仔细阅读操作手册，因为操作手册里介绍了重要的安全注意事项和正确的使用方法。

 该符号表示操作或使用工具时必须始终佩戴带侧面安全防护罩的安全眼镜或护目镜以降低眼部受伤的风险。

 该符号表示手、手指或身体其他部位有被压伤的风险。

 这是电击风险的符号。

基本安全规范

警告

请仔细阅读所有的安全注意事项和安全指导。如果不遵从这些安全指导可能会导致电击危险、火灾甚至其它严重的伤害事故的发生。

请保留这些安全注意事项和安全指导，以备将来参考。

电动工具的涵义是指带有电源线直接由外部电源提供电力和不带电源线由电池提供电力的两类设备。

工作区域安全

- 保持工作场所干净整洁和照明充分。混乱和昏暗的环境容易引起安全事故的发生。
- 不要在易燃易爆等的危险环境下操作机器，例如易燃易爆的液体、气体或粉尘环境下。电动工具易产生火花，会引燃这些粉尘或气体。
- 在操作机器时，使无关人员（包括小孩、旁观者、非工作人员等）远离工作现场。注意力分散容易导致安全事故的发生。

电气安全

- 电动工具插头应该和插座相匹配。任何时候都不要改变插头。不要与连接有接地电动工具的适配器插头一起使用。不改变插头并与插座相匹配将会降低电击事故的发生率。
- 避免身体与接地物体的表面接触，如金属管道、散热器、金属柜体和制冷设备。如果身体和接地物体接触将增加触电事故的发生率。
- 不要把电动工具放置雨中或潮湿的环境下。水进入电动工具将增加触电事故的发生率。
- 不要损坏电源线。不要把电源线用来拖拽电动工具。使电源线远离高温、油、尖锐边缘或移动物体。电源线损坏或卷入其它物体中都会增加电击事故的发生率。
- 当在室外使用电动工具时，请使用适合在室外工作的接线板。这样能降低电击事故的发生率。
- 避免在潮湿的环境下使用电动工具，请使用接地故障断路器（GFCI）保护装置。使用GFCI可以降低电击事故的发生率。

个人安全

- 使用电动工具时，保持头脑清醒，关注自己手头的工作。不要在疲惫或受到药物、酒精或毒品影响的情况下使用电动工具。如果在使用当中稍不留神，就会导致比较严重的伤害事故的发生。
- 使用个人防护用品，始终佩戴安全眼镜。个人防护用品包括防尘面罩、防滑安全保护鞋、安全帽或听力防护装置。适当使用这些防护用品，将减少人身伤害事故的发生。
- 不要无意识开机。在接通电源和/或装上电池或是拿起或携带工具前，确保开关处于关闭状态。当你携带电动工具，手指不小心触动开关或在开关处于开机状态时接通电动工具都会导致安全事故的发生。
- 开机前拿走所有调节工具，如扳手、钳子等。如果这些工具处在旋转部件上，将会导致人身伤害。
- 保持身体平衡，不要在操作机器时使身体失去平衡。这样会使你在意外情况下更好的控制工具。
- 正确着装。不要穿宽松的衣服或佩戴首饰。让你的衣服、头发和手套远离活动部件。宽松的衣服、首饰和长发容易卷入活动部件中。
- 如果工具用于粉尘收集装置的连接，请确保使用方法正确，从而减少与粉尘相关的事故。
- 如果开关不能工作，请不要使用电动工具。任何电动工具如果不能控制开关，都是非常危险的并且必须立即进行修理。
- 在对工具进行调整、更换附件、存放前必须先断开电源或者把电池取下来。这些措施可以预防意外接通工具的风险。

电动工具的使用与维护

- 不要过度使用电动工具，请在不同场合选择合适的电动工具。合适的工具将会使你更快、更安全地完成作业。

- 存放电动工具时注意不要让无关人员能够拿到，尤其是小孩。因为电动工具对于未经过培训的人员来说是非常危险的。
- 维护工具。检查是否活动部件的位置不正确、零件有损坏或其他可能影响工具正常使用的损坏状况，如果有，请在使用前务必修理好。许多事故的发生都是由于工具的维护不当造成的。
- 确保切割部件锋利清洁，这样工作时不易粘结，易于控制。
- 按照操作指南、工作环境要求和工作目的来正确使用电动工具及其附件和其它组件。如果工具与工作环境和目的不匹配，可能会导致危险的发生。

电池工具的使用和维护

- 请选择操作手册里指定的充电器对电池进行充电。适合某一特定类型电池的充电器如果用于其它类型的电池充电可能会引发火灾。
- 电动工具只可使用专用电池。使用任何其它类型电池可能导致人身伤害或火灾。
- 电池不使用时，使其远离金属物体，如回形针、硬币、钥匙、钉子、螺丝或其它小型的可能连接两极的金属物体。同时将电池两极短路可能导致灼伤或起火。
- 如果环境恶劣，电池的液体可能会溢出；不要接触电池液体。如果意外碰到，请用水冲洗。如果液体接触到眼睛，请就医。从电池中溢出的液体可能导致刺激或灼伤。

售后服务

- 请让经过培训合格的维修人员进行产品维修服务，并选择经过认证的合格零部件。这样可以确保工具的使用安全和保养正确。

其它安全须知

警告

本节内容是专门针对该电动工具的一些重要安全注意事项。在使用RP318压接工具前认真阅读此内容，可以减少电击危险或严重人身伤害事故的发生。

请注意保存好这些安全指导内容！

RP318便携式手提箱的夹层内有一份此操作手册，用于指导操作者正确使用该工具。

压接工具安全使用规范

- 请使用RP318压接工具的RIDGID®型压接附件（如压接钳、压接环、转换压接钳等）。将RP318压接工具用于其它用途可能损坏本工具和附件，甚至导致人身伤害。
- 压接过程中，请确保手指和手远离压接附件。否则压接钳或部件可能压伤手指和手，甚至导致骨折和切断。
- 永远不要试图维修损坏的压接钳、压接环、转换压接钳或其它部件。如果对这些附件进行焊接、打磨、钻孔或其它改变，在压接时会引起严重安全事故。报废损坏的压接钳，需要用新的进行更换。除了损坏的压接钳复位弹簧，切勿更换其他零件。详情请致电艾默生精密工具技术（上海）有限公司技术服务部门。
- 工具使用时将产生的力量巨大，可能打破零件造成伤害。使用过程中，请勿倚靠，并佩戴适当的保护装置，包括保护眼睛。
- 要确定所要压接的管件制造商，并使用对应的RIDGID压接工具及钳口。使用不正确的设备和方法可以导致压接不到位，损坏设备。要避免引起严重的人身伤害或死亡。

在使用RIDGID工具前，请阅读并理解以下内容：

- 操作手册
- 电池/充电器使用手册
- 其它与本工具一起使用的设备说明
- RPA 120/220 AC电源适配器使用手册

未能遵守所有的说明和警告可能导致财产损失和/或严重伤害。

如果对RIDGID®产品有任何疑问：

- 请联系艾默生精密工具技术（上海）有限公司
- 客户服务：400-820-5695
- 网址：www.RIDGID.cn

产品概述、规格和标准设备

概述

RP318压接工具和相应的标准压接钳配合使用，通过机械力施加于管件上形成不透水的永久密封。当按下RP318的开关后，一个内置的电机驱动液体进入工具的油缸，让凸轮向前运动并产生数千磅的压力施加于特殊设计的管件上。附件也可供其它用途使用。

整个压接过程大约持续7秒。当开始压接管件时，松开扳机，工具会立即停止，再次按下扳机，工具会自动继续工作直到完成整个过程。工具尾部的LED显示了不同的故障类型，如温度不正确、电池电量低或者需要维护保养等。

RP318带有两（2）个织物环，可用于装配肩带或扎绳。



图1 - RP318压接工具和标准型压接钳组

图2-LCD屏幕

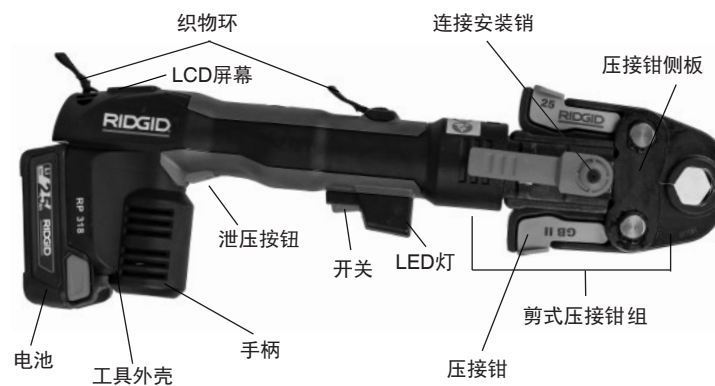

规格

RP318电动压接工具：

电机	
电压.....	18V DC
安培数.....	18 A
功率.....	324 W
重量.....	2.9 公斤 (仅工具-无电池)
凸轮压力.....	32kN
工作温度	
范围.....	15° F到122° F (-10° C到50° C)
工作周期.....	每分钟3次压接

标准设备

RP318如与电池一同订购，则提供的是2.5Ah的电池，5.0Ah电池可作为附件提供（见第10页）。更高安培数的电池每次充电可进行更多次的压接，但重量更重。

注意！里奇提供两种系列的压接钳和附件：

- 标准系列
- 紧凑型系列

这两个系列不能互换，即标准系列压接钳仅适用于标准系列的压接工具，如(RP340, RP318, CT-400)。同样，紧凑型系列压接钳仅适用于紧凑型系列的压接工具，如(紧凑型100-B, RP 200-B, RP 210-B)。

注意 管道材料的选择和接头的形式有该系统的设计人员和/或安装人员来负责。在安装前，应仔细权衡管道的使用环境，包括化学因素和温度条件。请咨询管道压接系统供应商来获得相关的选择信息。

工具完好性检查

警告

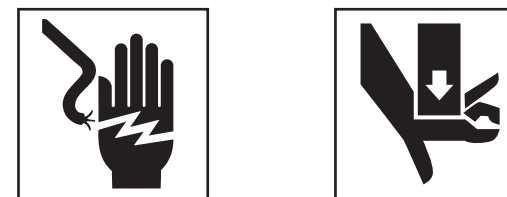

在每天使用压接工具前，请仔细检查工具和校正发现的问题，以减少电击、机械损伤、附件失效和其它原因引起的各种伤害事故发生的风险，并保护工具免受损坏。

1. 确保检查工具前已取下电池。检查电池是否完好。如果发现有任何不妥的地方，不要继续使用工具并立即进行修理。
2. 清除任何油脂、灰尘，尤其是手柄和控制元件上面。这样可以防止使用过程中工具发生滑脱。
3. 按照下列事项检查工具：
 - 装配适当，正确维护，产品完整。
 - 是否有任何破损，磨损，丢失，或结合部分错位。
 - 确保附件安装销可以顺利全开和全闭（图3和4）。
 - 确认开关自如，不卡或粘连。

- 警告标签存在和可读（图2）。
- 检查织物的循环是完好无损的，缝合不破。
- 任何其他影响安全和正常运行的情况。
- 如果发现有任何问题，不要使用压接工具直到问题被修复。

4. 按照操作手册要求检查和保养工具、各种附件、电池及充电器。



图2 压接工具警告标签

5. 保持操作时手掌干燥，装入充满电的电池。按一下红色按钮，打开压接工具。LED灯会亮起并一直亮着表示工具处于就绪状态。如果有其它情况，请根据故障诊断代码（第10页）来确定下一步行动，在工具恢复正常前不要使用。让手指和手远离凸轮，测试机器是否可以正确操作。当使用附件时，如果负载足够大，工具将会自锁以确保一个完整的压接过程能够完成。

6. 操作检查完毕后，用干燥的手取下电池。

工具组装和工作区域检查

警告



参照以下程序来组装工具和清理工作现场，可以减少电击、火灾、机械损伤或其他原因引起的伤害事故的发生，同时保护工具和管道系统完好。

- 从以下几个方面检查工作区域：
 - 照明充分
 - 可燃液体、气体或粉尘容易引起燃烧。请不要在这些环境下使用工具，直到确认并进行整改。压接工具没有防爆保护措施，因此会产生火花。
 - 在清洁、干燥、稳定的环境下操作。不要站在水中使用工具。
- 检查所要进行的工作，根据应用场合来选择合适的里奇工具及附件。如果附件使用错误，也会引起伤害事故和工具损坏及管道连接不符合密封要求的情况。如需完整的里奇电动压接工具附件清单，请访问 www.RIDGID.cn 网站查询产品目录或致电艾默生精密工具技术（上海）有限公司技术服务热线400-820-5695咨询。确保已根据工具和附件的使用说明来对其进行检查。
- 权衡工作区域看是否需要进行隔离，使旁观者远离工作地点，因为旁观者会使操作者注意力分散。
- 确保已取下电池，然后解锁并完全打开附件安装销（见图3和图4）。如果工具中已有附件，则将其取下。
- 装入正确的附件，然后完全闭合附件安装销，并旋转到锁定位置，如图3。附件安装销必须完全闭合并锁紧，以防止工具在使用过程中被损坏。



图3 完全闭合/锁紧的安装销



图4 完全打开/解锁的安装销

操作指南

警告



始终佩戴安全防护镜来保护眼睛免受粉尘或其它异物的伤害。

在压接循环过程中，保持手指和手远离附件。否则手指和手可能被工具或附件、工件和其它物件压伤甚至导致骨折或切断。

按照操作指南进行操作，减少受伤和工具被损坏的风险。

注意 以下操作指南部分适用于几种类型的压接工具附件的使用。严格遵守关于压接工具附件的特别使用规范和管件生产厂家的安装指导规范。否则，会使管道安装不正确而产生泄漏，从而导致财产损失。

压接前的准备工作

- 确保工作区域没有闲杂人员和分散注意力的因素影响，且工具正确组装，工作场所符合工作要求。
- 按照管件生产厂家的要求进行管道连接。

使用典型的剪式压接钳对管件进行压接

- 确保RP318安装了正确的压接钳，且安装销完全闭合且锁紧。（见“工具组装和工作区域检查”章节）
- 将充满电的电池装入手柄中。
- 按下压接钳臂以打开压接钳（图5）。
- 将打开的压接钳卡在管件周围（图6）。确保按照管件厂商的使用手册，将压接钳完全对准管件。不要让工具和压接钳直接悬挂在管件上，以避免工具不慎跌落造成不必要的伤害或死亡事故。
- 确保遵循相应管件系统说明中的要求（即管道插入管件的深度符合要求）。



图5 打开剪式压接钳



图6 将剪式压接钳扣住管件



图7 RP318压接工具与管道垂直

- 确保压接钳和工具与管道垂直（图7），如果压接钳和工具未与管道垂直，则在压接过程中工具会自己尝试对齐。这样就会导致压接不当或工具损坏。
- 按下并松开开关，让工具接通。工具前部的LED灯会一直点亮，表明工具随时可用。

注意！如果150秒钟不对工具进行操作，它将自动关闭。要打开工具，需要再次按下开关。

按下工具的扳机（图1）。让手和手指远离压接钳，以避免被压伤。压接循环大约为7秒。一旦一次压接循环开始，且滚轴碰到压接钳臂时，工具会锁定并自动完成压接循环。当开始压接管件时，松开扳机，工具会立即停止，再次按下扳机，工具会自动继续工作直到完成整个过程。这样能确保压接管件的一致性、完整性和可重复性。

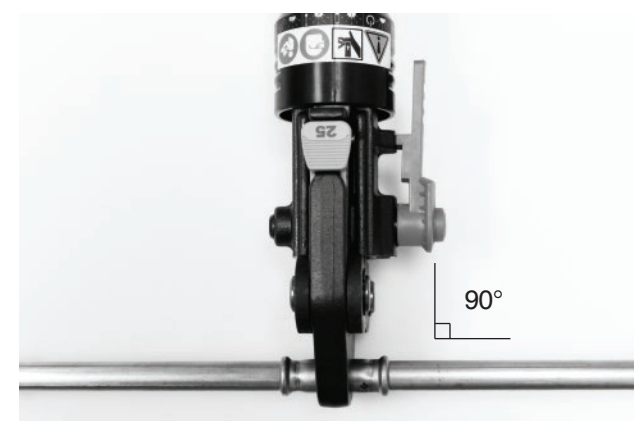
注意 如果电池电量太低而不能完成一个压接循环操作，则RP318压接工具会自动关机。此时，LED灯不断闪烁进行提示。重新装上充满电的电池重复以上的操作过程。

如果压接过程中电池没电或工具发生故障，此时要使滚轴复位或从管道上取下工具，就必须按下泄压按钮(图1)。如果发生此类情况，则需要对连接处再进行一次压接以确保压接完整。

8. 压接循环完成后，按下压接钳臂打开压接钳。

9. 从管道上取下RP318和压接钳，检查压接情况。小心压接过程中可能产生的锋利边角。

使用典型的转换压接钳和压接环组件进行管件压接

1. 确保RP318压接工具安装了正确的转换压接钳，且安装销完全关闭并锁紧。
2. 将充满电的电池插入RP318后部。
3. 确保管道插入管件的深度正确，即符合管件系统操作手册中的要求。
4. 打开压接环并将其以正确的角度放在管件上(图8)。将压接环与管件按照管件系统操作手册中的要求进行对齐。在压接前，再次检查管道插入管件的深度。
5. 按下转换压接钳臂打开转换压接钳组件。将转换压接钳两端卡入压接环的转换压接钳口中(图9)。确保转换压接钳两端完全卡入转换压接钳口中。不要让工具和转换压接钳悬挂在管件上，以避免工具意外掉落而引起伤害或死亡。
6. 按下并松开开关，让工具接通。工具前部的LED灯会一直点亮，表明工具随时可用。

注意! 如果150秒钟不对工具进行操作，它将自动关闭。要打开工具，需要再次按下开关。

按下工具的开关。让手和手指远离转换压接钳，以避免被压伤。压接循环大约为七(7)秒。一旦一次压接循环开始，且滚轴碰到转换压接钳臂时，工具会锁定并自动完成压接循环。当开始压接管件时，松开扳机，工具会立即停止，再次按下扳机，工具会自动继续工作直到完成整个过程。这样能确保压接管件的一致性、完整性和可重复性。



图8 将转换压接环安装到管件上



图9 将转换压接环连接到压接环上

注意 如果电池电量太低而不能完成一个压接循环操作，则RP318压接工具会自动关机。此时，LED灯不断闪烁进行提示。重新装上充满电的电池重复以上的操作过程。

如果压接过程中电池没电或工具发生故障，此时要使滚轴复位或从管道上取下工具，就必须按下泄压按钮(图1)。如果发生此类情况，则需要对连接处再进行一次压接以确保压接完整。

7. 压接循环完成后，按下转换压接钳臂将转换压接钳打开并从压接环上取下。用手拿住压接环并打开组件将其从管件上取下。小心压接过程中可能产生的锋利边角。

检查压接情况

1. 检查压接后的管件。如果管件上有厂家附带的控制环和/或控制标签，则将其取下。厂家提供这些标示是为了表示这些管件还没有被压接过，去掉这些标示就说明这些管件已经被压接过了。

检查以下几个方面：

- 管件与管道错位严重。注意：压接后有稍许错位被视为正常。
- 管道插入管件的长度不够 – 再次检查管道上正确的插入长度标记是否和管件端部吻合。
- 压接钳或压接环没有和管件对齐，管件变形。按照管件厂家的标准来检查是否有其它问题。
- 如果发现其它问题，则应拆下有问题的部分，换上一个新的管件和管道进行压接操作。

2. 按照正常操作和所在地的标准来测试系统。
3. 对于其它特殊检测标准，请参看压接系统操作手册。

维护指南

警告

在维护和调整工具之前，确保已取下电池。

清洁和润滑

1. 每天用干净的布擦拭工具。
2. 检查工具的附件安装销，必要时用硅润滑剂对销进行润滑。

3. 每次使用后检查附件中的复位弹簧。附件应只需手指稍许用力就能自由打开和关闭。

需要里奇授权维修中心提供的维修服务

在30000次工作循环后，只要工具开机，LED灯就会闪烁，这表明需要进行维护保养和校正机器。LED灯闪烁后，如果不进行维护保养还继续工作循环2000次(共32000次)，工具将自动停机。

维护保养服务为有偿付费项目。

附件

警告

仅下所列附件可与RP318压接工具一同使用。对于应配合其它相应工具使用的其它附件，如果用于本机器则会导致机器损坏。为了防止意外发生，请使用为RP318专门设计的附件或推荐使用的附件。具体见下表。

艾默生精密工具技术(上海)有限公司提供标准型压接附件来配合标准型压接工具一同使用。请按照管件系统来选择合适的压接附件。如果要得到完整的压接附件目录，请访问www.RIDGID.cn网站或致电艾默生精密工具技术(上海)有限公司技术服务热线400-820-5695。

RP318压接工具附件

目录编号	产品说明
56513	18V 2.5Ah高级锂电池组
56518	18V 5.0Ah高级锂电池组
64388	18V高级锂电池充电器
47133	手提箱(塑料)
44823	电源适配器 18V/230V

存放

将电池从工具上取下，并将其与工具一起存放在手提箱内。不要存放在过热或过冷的地方。当油温不在15°F(-10°C)到122°F(50°C)范围内时，工具的温度传感器不会允许工具启动。因此在使用前必须使工具处于操作规范所规定的温度范围内。工具前部的红色LED灯会以持续的闪烁两次然后停顿的方式作为提醒。

警告 工具要存放在干燥、安全、能够上锁的地方，避免儿童、无关人员能够取到。未经过培训的人员使用本工具将十分危险。

维修与服务

警告

不正确的维修与服务会使工具处于不安全的工作条件。

必须由经过艾默生精密工具技术（上海）有限公司授权的维修中心来对RP318压接工具进行维修。如果由未经授权的个人进行维修，则工具固定器上需进行标记。

如有任何维修与维护的要求，请致电艾默生精密工具技术（上海）有限公司技术服务热线400-820-5695或访问 www.RIDGID.cn 网站获得最近的授权压接工具服务中心信息。

机器处置

本设备的部分零件由珍贵材料制成，并可进行回收。您可以寻找您所在地的专业回收公司。

机器的处置应遵循所有适用的法规。联系您当地的废品管理机构了解更多信息。

故障诊断

故障现象	原因	解决方法
按下开关时，工具不开机	电池没电或电池失效	换上充满电的电池/对电池充电
	电池未正确装入工具手柄	确保电池装入正确
按下扳机或压接过程中工具突然关机，LED灯闪烁	电池电量太低	换上充满电的电池/对电池充电
	工具和电池过热/过冷	把工具和电池恢复到规定的温度范围内15°F (-10°C) 到 122°F (50°C) 注意：如果压接过程中断，必须再重新进行一次压接，否则会有泄漏。
LED灯闪烁两次然后停止，不停以此方式反复。（按下开关后工具不启动）	工具和电池过热/过冷	把工具和电池恢复到规定的温度范围内15°F (-10°C) 到 122°F (50°C) 注意：如果压接过程中断，必须再重新进行一次压接，否则会有泄漏。
工具打开后，LED灯闪烁三次然后停止，不停以此方式反复。但工具可正常使用。	30000次压接循环后需要进行维护/校准。	请致电艾默生精密工具技术（上海）有限公司服务热线：400-820-5695。
LED灯闪烁三次然后停止，不停以此方式反复。按下开关后工具不工作。	32000次压接循环后需要进行维护/校准，或检测到工具故障。工具已自锁，直到接受维护/校准后才能恢复正常功能。	请致电艾默生精密工具技术（上海）有限公司服务热线：400-820-5695。
	压接过程没有正常完成	按下压力释放阀，取下压接钳。检查管件并重新压接。
压接钳锁死在管件上	压接钳与管子尺寸、材料不匹配	选择正确的压接钳
	工具与管子不垂直	换上新的管件与管子重新压接，确保工具与管子垂直
	压接钳没有与管件对准	换上新的管件与管子重新压接，确保压接钳正确对准管件
压接过程没有完全完成	压接钳没有与管件对准	换上新的管件与管子重新压接，确保压接钳正确对准管件
	工具需要维修	请致电艾默生精密工具技术（上海）有限公司服务热线：400-820-5695。

RP318诊断代码

故障诊断	状态	故障说明	图标
	常亮	机器打开	
	不断闪烁	电池需要充电	
	闪烁两次然后停顿，不停反复	超出温度范围，15°F (-10°C) 到 122°F (50°C)	
	闪烁三次然后停顿，不停反复	30000次压接循环后提示进行维护或工具出现故障。注意：32000次压接循环后工具会锁定。	

图10 LED灯诊断代码

里奇工具保证

保证内容

艾默生精密工具技术（上海）有限公司对其产品的生产工艺及物料质量提供保证，但因非生产工艺或物料引起的任何问题除外。

保证时效及范围

艾默生精密工具技术（上海）有限公司对在中国大陆购买并使用的电动水管压接工具产品提供有限保证，具体为：

- 电动水管压接工具（RP318），保证期为一年。
- 上述产品保证期限均自购买之日起开始计算（以经销商开具的原始有效销售发票为准）。

非保证范围

由于不遵守操作说明、不正确使用、异常的环境条件、不适当的操作条件、使用非原装附件、部件或零件所造成的损坏，以及易损件（诸如刀片、模头、液压密封圈、液压油和充电电池等）等情况不在本保证之内。艾默生精密工具技术（上海）有限公司不承担任何非产品缺陷所致损失。

维修服务

经艾默生精密工具技术（上海）有限公司专业鉴定，用户就保证范围内产品享有维修服务：

- 在保证期内，对属于物料瑕疵或生产工艺缺陷的产品予以免费维修；如果产品在保证期内经过三次维修后仍无法正常使用，则予以更换相同或同类产品（同类产品如有价差，多退少补）。
- 对因非物料瑕疵或生产工艺缺陷的产品予以收费维修。
- 所有超出保证期的产品均为收费维修。

获得维修服务的方法

需自费将完整的产品送至艾默生精密工具技术（上海）有限公司当地代理商或者艾默生精密工具技术（上海）有限公司所核定的服务中心，并出示原始发票以供核对（收费维修的产品除外）。

法律保障

用户有权得到中国大陆相应的明确的法律保护。

无其它的保证

除本保证外，任何员工、代理商、经销商或其他任何人员均无权代表艾默生精密工具技术（上海）有限公司改变本保证或提供其它保证。

艾默生精密工具技术（上海）有限公司对以上保证条款持有最终解释权。

Table of Contents

Recording Form For Machine Serial Number.....16

Safety Symbols.....17

General Safety Rules

 Work Area Safety.....17

 Electrical Safety17

 Personal Safety18

 Power Tool Use And Care18

 Battery Tool Use And Care18

 Service.....18

Specific Safety Information

 Press Tool Safety.....19

Description, Specifications And Standard Equipment

 Description.....19

 Specifications.....19

 Standard Equipment20

Tool Inspection.....20

Tool And Work Area Set-Up.....21

Operating Instructions

 Preparing The Connection22

 Pressing A Fitting With Typical Scissor Jaws22

 Pressing A Fitting With Typical Actuator And Press Ring Set23

 Inspecting The Pressed Connection24

Maintenance Instructions

 Cleaning And Lubrication.....24

 Required Maintenance At RIDGID Authorized Service Center24

Accessories.....24

Storage.....24

Service And Repair.....25

Machine Disposal.....25

Troubleshooting.....26

RP318 Diagnostic Codes.....27

Lifetime Warranty.....28

Press Tool



RP318 Press Tool	
Record Serial Number below and retain product serial number which is located on nameplate.	
Serial No.	

Safety Symbols

In this operator's manual and on the product, safety symbols and signal words are used to communicate important safety information. This section is provided to improve understanding of these signal words and symbols.

 This is the safety alert symbol. It is used to alert you to potential personal injury hazards. Obey all safety messages that follow this symbol to avoid possible injury or death.

⚠ DANGER DANGER indicates a hazardous situation which, if not avoided, will result in death or serious injury.

⚠ WARNING WARNING indicates a hazardous situation which, if not avoided, could result in death or serious injury.

⚠ CAUTION CAUTION indicates a hazardous situation which, if not avoided, could result in minor or moderate injury.

NOTICE NOTICE indicates information that relates to the protection of property.

 This symbol means read the operator's manual carefully before using the equipment. The operator's manual contains important information on the safe and proper operation of the equipment.

 This symbol means always wear safety glasses with side shields or goggles when handling or using this equipment to reduce the risk of eye injury.

 This symbol indicates the risk of hands, fingers or other body parts being crushed.

 This symbol indicates the risk of electrical shock.

General Safety Rules

⚠ WARNING
Read all safety warnings and instructions. Failure to follow the warnings and instructions may result in electric shock, fire and/or serious injury.

SAVE ALL WARNINGS AND INSTRUCTIONS FOR FUTURE REFERENCE!

The term "power tool" in the warnings refers to your mains-operated (corded) power tool or battery-operated (cordless) power tool.

Work Area Safety

- **Keep your work area clean and well lit.** Cluttered or dark areas invite accidents.
- **Do not operate power tools in explosive atmospheres, such as in the presence of flammable liquids, gases, or dust.** Power tools create sparks which may ignite the dust or fumes.
- **Keep children and by-standers away while operating a power tool.** Distractions can cause you to lose control.

Electrical Safety

- **Power tool plugs must match the outlet. Never**

modify the plug in any way. Do not use any adapter plugs with earthed (grounded) power tools. Unmodified plugs and matching outlets will reduce risk of electric shock.

- **Avoid body contact with earthed or grounded surfaces such as pipes, radiators, ranges and refrigerators.** There is an increased risk of electrical shock if your body is earthed or grounded.
- **Do not expose power tools to rain or wet conditions.** Water entering a power tool will increase the risk of electrical shock.
- **Do not abuse the cord. Never use the cord for carrying, pulling or unplugging the power tool. Keep cord away from heat, oil, sharp edges or moving parts.** Damaged or entangled cords increase the risk of electric shock.
- **When operating a power tool outdoors, use an extension cord suitable for outdoor use.** Use of a cord suitable for outdoor use reduces the risk of electric shock.
- **If operating a power tool in a damp location is unavoidable, use a ground fault circuit interrupter (GFCI) protected supply.** Use of a GFCI reduces the risk of electric shock.

Personal Safety

- **Stay alert, watch what you are doing and use common sense when operating a power tool. Do not use a power tool while you are tired or under the influence of drugs, alcohol, or medication.** A moment of inattention while operating power tools may result in serious personal injury.
 - **Use personal protective equipment. Always wear eye protection.** Protective equipment such as dust mask, non-skid safety shoes, hard hat, or hearing protection used for appropriate conditions will reduce personal injuries.
 - **Prevent unintentional starting. Ensure the switch is in the OFF-position before connecting to power source and/or battery pack, picking up or carrying the tool.** Carrying power tools with your finger on the switch or energizing power tools that have the switch ON invites accidents.
 - **Remove any adjusting key or wrench before turning the power tool ON.** A wrench or a key left attached to a rotating part of the power tool may result in personal injury.
 - **Do not overreach. Keep proper footing and balance at all times.** This enables better control of the power tool in unexpected situations.
 - **Dress properly. Do not wear loose clothing or jewelry. Keep your hair, clothing, and gloves away from moving parts.** Loose clothes, jewelry, or long hair can be caught in moving parts.
 - **If devices are provided for the connection of dust extraction and collection facilities, ensure these are connected and properly used.** Use of dust collection can reduce dust-related hazards.
- ### Power Tool Use And Care
- **Do not force power tool. Use the correct power tool for your application.** The correct power tool will do the job better and safer at the rate for which it is designed.
 - **Do not use power tool if the switch does not turn it On and Off.** Any power tool that cannot be controlled with the switch is dangerous and must be repaired.
 - **Disconnect the battery pack from the power tool before making any adjustments, changing accessories, or storing power tools.** Such preventive safety measures reduce the risk of starting the power tool accidentally.

- **Store idle power tools out of the reach of children and do not allow persons unfamiliar with the power tool or these instructions to operate the power tool.** Power tools are dangerous in the hands of untrained users.
- **Maintain power tools. Check for misalignment or binding of moving parts, breakage of parts and any other condition that may affect the power tool's operation. If damaged, have the power tool repaired before use.** Many accidents are caused by poorly maintained power tools.
- **Keep cutting tools sharp and clean.** Properly maintained cutting tools with sharp cutting edges are less likely to bind and are easier to control.
- **Use the power tool, accessories and tool bits etc. in accordance with these instructions, taking into account the working conditions and the work to be performed.** Use of the power tool for operations different from those intended could result in a hazardous situation.

Battery Tool Use And Care

- **Recharge only with the charger specified by the manufacturer.** A charger that is suitable for one type of battery pack may create a risk of fire when used with another battery pack.
- **Use power tools only with specifically designated battery packs.** Use of any other battery packs may create a risk of injury and fire.
- **When battery pack is not in use, keep it away from other metal objects, like paper clips, coins, keys, nails, screws or other small metal objects that can make a connection from one terminal to another.** Shorting the battery terminals together may cause burns or a fire.
- **Under abusive conditions, liquid may be ejected from the battery; avoid contact. If contact accidentally occurs, flush with water. If liquid contacts eyes, additionally seek medical help.** Liquid ejected from the battery may cause irritation or burns.

Service

- **Have your power tool serviced by a qualified repair person using only identical replacement parts.** This will ensure that the safety of the power tool is maintained.

Specific Safety Information

⚠ WARNING

This section contains important safety information that is specific to this tool.

Read these precautions carefully before using the RP318 Press Tool to reduce the risk of electrical shock or serious personal injury.

SAVE THESE INSTRUCTIONS!

A compartment in the RP318 carrying case is included to keep this manual with the machine for use by the operator.

Press Tool Safety

- Use the RP318 Press Tool only with RIDGID® standard pressing attachments (jaws, press ring, actuator, etc.). Other uses or modifying the RP318 Press Tool for other applications may damage the press tool, damage the attachments and/or cause personal injury.
- Keep your fingers and hands away from pressing attachments during press cycle. Your fingers or hands can be crushed, fractured or amputated if they become caught between the jaws or between these components and any other object.
- Never attempt to repair damaged jaws, press ring, actuator or other attachments. An attachment that has been welded, ground, drilled or modified in any manner can shatter during pressing resulting in serious injury. Discard the entire damaged jaws. Replace with new jaws. Never replace individual components except for damaged jaw return springs. Please call Ridge Tool Company, Technical Services for availability.
- Large forces are generated during product use that can break or throw parts and cause injury. Stand clear during use and wear appropriate protective equipment, including eye protection.
- Only use RIDGID Press Tools and Jaws when specified by the press fitting manufacturer. Use of incorrect equipment and methods can cause incomplete joints, damage the equipment, void warranties or cause severe personal injury or death.
- Before operating a RIDGID RP318 press tool, Read and understand:
 - This operator's manual,
 - The attachment instructions,
 - The battery/charger manual,
 - RPA 120/220 AC Power (Mains) Adapter Instructions,
 - The fitting manufacturer's installation instructions,
 - The instructions for any other equipment used with this tool,
 Failure to follow all instructions and warnings may result in property damage and/or serious injury.

If you have any question concerning this RIDGID® product:

- Contact your local RIDGID® distributor.
- Visit www.RIDGID.com.cn to find your local Ridge Tool contact point.
- Call 400-820-5695.

Description, Specifications And Standard Equipment

Description

The RP318 Press Tool, when used with appropriate RIDGID standard pressing attachments, is designed to mechanically press fittings onto tubing to create a watertight and permanent seal. When the switch on the RP318 is depressed, an internal electric motor powers a hydraulic pump which forces fluid into the cylinder of the tool, forcing the ram forward and applying thousands of pounds of pressing force onto specially designed fittings. Attachments are also available for other uses.

The entire cycle duration is approximately seven (7) seconds. Once the cycle begins to deform a fitting, press the red switch to start the tool until completion. Release the switch the cycle will be stopped. The LED light on the back of the tool will blink to indicate issues such as improper temperature, low battery, or maintenance required.

The RP318 comes with two (2) fabric loops that can be used with appropriate attachments such as shoulder straps or tie off lines.

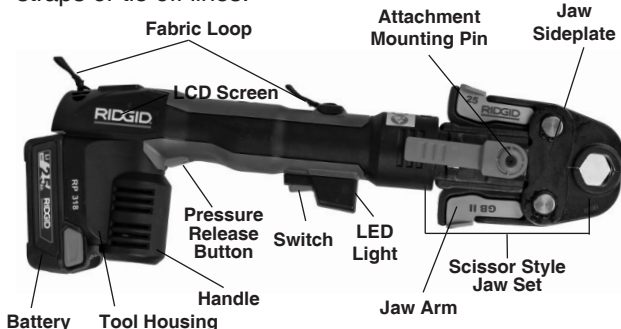
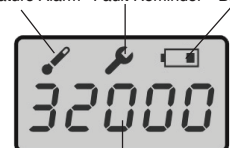

Figure 1 – RP318 Press Tool And Standard Series Jaw

Temperature Alarm Fault Reminder Battery Power



The Times of Press

Figure 2 – LCD Screen

Specifications

RP318 Battery Press Tool:

Motor	
Voltage	18V DC
Amperage	18 Amp
Power	324 Watts
Weight	2.9 Kg (Tool Only - No Battery)
Ram Force	32 kN
Operating Temperature	
Range	15° F to 122° F (-10° C to 50° C)
Duty Cycle	3 Crimp /min.

Standard Equipment

The RP318, if ordered with batteries, comes with 2.0Ah batteries. 4.0 batteries are available as accessories (See Page 24). Higher amp hour batteries allow more press connections per charge, but also weigh more.

NOTE! RIDGID jaws and attachments are offered in two "series".

- Standard Series
- Compact Series

These series are not interchangeable. Only standard series jaws will work with standard series tools (RP 330, RP 340, RP318, CT-400).

Similarly, only compact series jaws will work with the compact series tools (Compact 100-B, RP 200-B, RP 210-B).

NOTICE Selection of appropriate materials and joining methods is the responsibility of the system designer and/or installer. Before any installation is attempted, careful evaluation of the specific service environment, including chemical environment and service temperature, should be completed. Consult Press Fitting System manufacturer for selection information.

Tool Inspection

⚠ WARNING



Daily before use, inspect your press tool and correct any problems to reduce the risk of serious injury from electric shock, crushing injuries, attachment failure and other causes, and prevent tool damage.

1. Make sure that the press tool battery is removed. Inspect the battery for damage. If any damage or modifications are found, do not use until the battery has been properly repaired or replaced.
2. Clean any oil, grease or dirt from the equipment, especially the handles and controls. This helps to prevent the machine or controls from slipping from your grip.
3. Inspect the press tool for the following:
 - Proper assembly, maintenance and completeness.
 - Any broken, worn, missing, misaligned or binding parts.

- Make sure that the attachment mounting pin moves smoothly between the fully open and fully closed positions (Figure 3 and 4).
- Confirm that the switch moves freely and does not bind or stick.
- Presence and readability of the warning label (Figure 2).
- Check that the fabric loops are undamaged and that the stitching is not torn.
- any other condition which may prevent safe and normal operation.

If any problems are found, do not use the press tool until the problems have been repaired.

4. Inspect and maintain the tool attachments, battery and charger as directed in their instructions.



Figure 2 – Press Tool Warning Labels

5. With dry hands, insert a fully charged battery. Press the red switch one time in order to turn the press tool ON. The LED light should turn ON and remain on to indicate that the tool is ready for use. If any other conditions exist, use the Diagnostic Codes information (Figure 10) to determine the next step and do not use the tool until it is working properly. With your hands and fingers away from the tool ram, test the operation of the switch to confirm proper operation. When used with an attachment, once the tool sees enough load it will lock on to insure that a complete press is made.
6. Once the operation has been checked, with dry hands remove the battery.

Tool And Work Area Set-Up

WARNING



Set up the press tool and work area according to these procedures to reduce the risk of injury from electric shock, fire, crushing injuries and other causes, and prevent tool and system damage.

1. Check work area for:
 - Adequate lighting.
 - Flammable liquids, vapors or dust that may ignite. If present, do not work in area until sources have been identified and corrected. The press tool is not explosion proof and can cause sparks.
 - Clear, level, stable and dry place for operator. Do not use the machine while standing in water.
2. Inspect the work to be done and determine the correct RIDGID tool and attachment(s) for the application. Using an incorrect attachment for an application can cause injury, damage the tool and make incomplete connections. For a complete listing of RIDGID attachments available for this tool, see the Ridge Tool Catalog on line at www.RIDGID.com.cn or call Ridge Tool Technical Services 400-820-5695. Make sure that the tool and attachment have been inspected as directed in their instructions.
3. Evaluate the work area and determine if any barriers are needed to keep bystanders out. Bystanders can distract the tool operator during use.
4. Confirm that the battery is removed then unlock and fully open the attachment mounting pin. See Figure 3 and Figure 4. If there is an attachment in the tool, slide it out of the tool.
5. Slide the correct attachment in the press tool then fully close the attachment mounting pin and rotate into the locked position as shown in Figure 3. **The attachment mounting pin must be fully closed and locked to prevent tool damage during use.**



Figure 3 – Fully Closed/Locked Mounting Pin

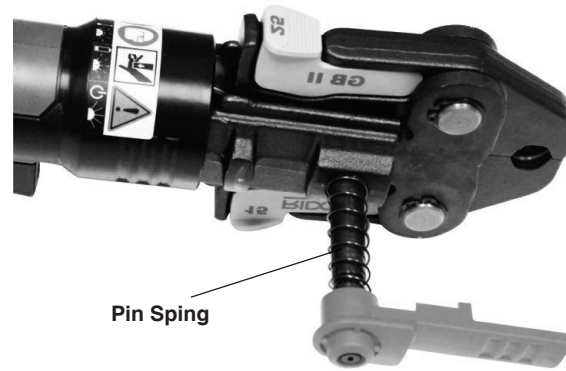

Figure 4 – Fully Open/Unlocked Mounting Pin

Operating Instructions

WARNING



Always wear eye protection to protect your eyes against dirt and other foreign objects.

Keep your fingers and hands away from the tool attachment during the press cycle. Your fingers or hands can be crushed, fractured or amputated in the attachment or tool or between the attachment, work piece and other objects.

Follow operating instructions to reduce the risk of injury from crushing and other causes and to prevent tool damage.

NOTICE These instructions are generalized practices for several types of press tool attachments. Always follow the specific instructions for the press tool attachment

being used and the fitting manufacturers specific installation instructions. Failure to follow the specific attachment and fitting installation instructions may result in improper press connections that can lead to extensive property damage.

Preparing The Connection

1. Make sure that the work area is free of bystanders and other distractions and that the tool and work area has been properly set up.
2. Prepare the connection according to the fitting manufacturers instructions.

Pressing A Fitting With Typical Scissor Jaws

1. Make sure the RP318 Press Tool has the correct jaw installed and the mounting pin is fully closed and locked. (See Tool And Work Area Set Up Section.)
2. Insert fully charged battery into the base of the handle.
3. Squeeze jaw arms to open the jaws (Figure 5).
4. Place open jaws around the fitting (Figure 6). Make sure the contour of the jaws is properly aligned with the contour of the fitting as specified in Fitting Systems operator's manual. Do not attempt to hang the jaws and tool from fitting. Tool could unexpectedly drop and cause serious injury or death.
5. Make sure the tubing is inserted to the proper depth in fitting, as specified in the appropriate fitting system's instructions.

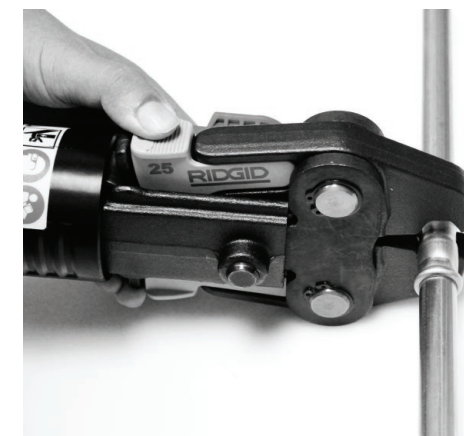

Figure 5 – Opening The Scissor-Style Jaws

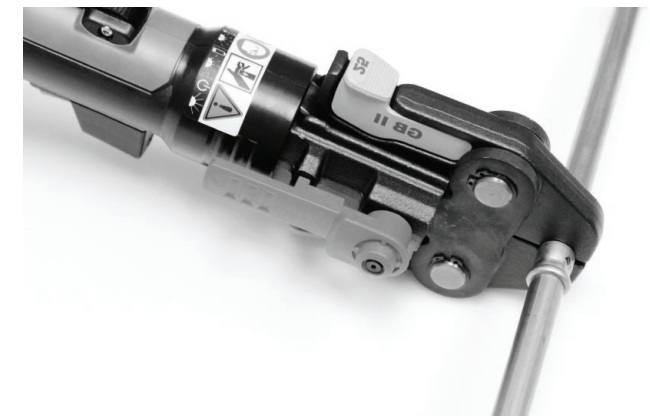

Figure 6 – Placing Scissor-Style Jaw Set Around Fitting

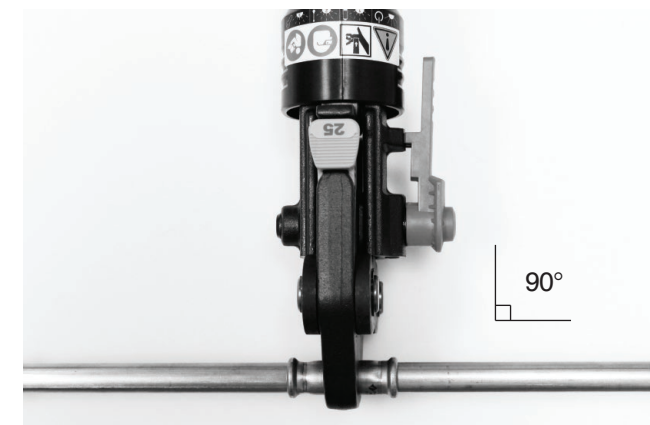

Figure 7 – RP318 Tool Square To Tubing

6. Make sure the jaws and tool are square to the tubing. (Figure 7) If the jaw and tool are not square to the tube, they will try to align as the press is made. This could cause an improperly pressed fitting or damage the tool.
7. Depress and release the switch one time to turn tool ON. The LED light on the front of the tool should be solidly illuminated indicating the tool is ready to press.

NOTE! Tool will automatically turn OFF if left unused for 150 seconds. To turn tool ON, it is necessary to once again depress the switch.

Depress the tool trigger switch (Figure 1). Keep fingers and hands away from the jaws to avoid crushing injuries in jaws and between jaws and surroundings. The press cycle takes about seven (7) seconds. Once a press cycle begins and the rollers contact the jaw arms, the tool will lock-on and automatically complete the press cycle. Releasing the trigger will stop the tool once the pressing process has begun. Pressing the switch again, tool will continue until completion. This assures consistent, repeatable press joint integrity.

NOTICE The RP318 Press Tool will turn off automatically if the battery is too low to successfully complete a pressed connection. This will be indicated by a continuous ON/OFF flashing of the LED light. A fully charged battery should be inserted in the tool and the pressed connection should be repeated as indicated above.

To retract the rollers and remove the tool from the fitting if battery dies or tool malfunctions during pressed connection. If it is necessary to retract the rollers to remove the tool from the fitting, press the pressure release button (Figure 1). If this happens, the connection will need to be pressed again to insure completion.

8. After the cycle is complete, squeeze jaw arms to open the jaws.
9. Remove the RP318 and jaws from tube and inspect the pressed connection. Avoid sharp edges that may have formed on the fitting during the pressing operation.

Pressing A Fitting With Typical Actuator And Press Ring Set

1. Make sure the RP318 Press Tool has the correct actuator installed and the mounting pin is fully closed and locked.
2. Insert fully charged battery into the back of the RP318.
3. Make sure the tubing is inserted to the proper depth in fitting, as specified in the appropriate fitting system's operator's manual.
4. Open the appropriate press ring and place at right angle onto the fitting (Figure 8). Align ring with fitting according to fitting system's operator's manual. Re-check insertion depth before completing press process.
5. Squeeze actuator arms to open the actuator assembly. Engage actuator ends into the actuator pockets in the press ring (Figure 9). Make sure actuator ends are fully engaged in pockets. Do not attempt to hang tool and actuator from press ring. Tool could unexpectedly drop causing serious injury or death.
6. Depress and release the switch one time to turn tool ON. The LED light on the front of the tool should solidly illuminate indicating the tool is ready to press.

NOTE! Tool will automatically turn OFF if left unused for 150 seconds. To turn tool ON, it is necessary to once again depress and release the switch of the tool.

Depress the tool switch. Keep fingers and hands away from actuator and press ring to avoid crushing injuries in attachments and between attachments and surroundings. The press cycle takes about seven (7) seconds. Once a press cycle begins and the rollers contact the actuator arms, the tool will lock-on and automatically complete the press cycle. Releasing the trigger will stop the tool once the pressing process has begun. Pressing the switch again, tool will continue until completion. This assures consistent, repeatable press joint integrity.



Figure 8 – Installing Press Ring Onto Fitting



Figure 9 – Attaching Actuator To Press Ring

NOTICE The RP318 Press Tool will turn OFF automatically if the battery is too low to successfully complete a pressed connection. This will be indicated by a continuous ON/OFF flashing of the LED light. A fully charged battery should be inserted in the tool and pressed connection should be repeated as indicated above.

To retract the rollers and remove the tool from the fitting if battery dies or tool malfunctions during pressed connection. If it is necessary to retract the rollers to remove the tool from the fitting, press the pressure release button (Figure 1). If this happens, the connection will need to be pressed again to ensure completion.

7. After cycle is complete, squeeze actuator arms to open and separate actuator from press ring. Remove the press ring from fitting by manually grasping ring halves and opening assembly. Avoid any sharp edges which may have formed on fitting during pressing operation.

Inspecting The Pressed Connection

1. Inspect the pressed fitting. If the fitting is supplied with a control ring and/or a control label by the fitting manufacturer, remove it. Control rings and labels are supplied by the manufacturer to indicate that the fitting has not yet been pressed. Removal of the control ring and label indicates to others that the connection has been pressed.

Look for the following:

- Excessive misalignment of the tubes. Note that a slight amount of misalignment at the pressed connection is considered normal.
- Tubes that are not fully inserted into the fitting – double check the insertion marks made on the tube to see that they are still aligned with the end of the fitting.
- Incorrect jaw or ring alignment with the fitting contour, distorted or deformed fitting.
- Any other issues per the fitting manufacturer.

If any of these problems are found, then removal of the fitting is required and a new fitting and tube will need to be prepared and pressed in its place.

2. Test system in accordance with normal practice and local codes.
3. See fitting system's operator's manual for specific inspection criteria.

Maintenance Instructions

⚠ WARNING

Make sure battery is removed from tool before performing maintenance or making any adjustment.

Cleaning And Lubrication

1. Wipe the tool clean daily with a clean dry cloth.
2. Inspect the attachment mounting pin and lubricate the pin with silicone lubricant as needed.

3. Check return springs in attachments with each use. Attachments should open and close freely with only moderate finger effort required.

Required Maintenance At RIDGID Authorized Service Center

After 30,000 cycles, the LED light will flash three times then pause continuously, to indicate that it is time for maintenance and recalibration. The tool will not run if it is not serviced within 2,000 cycles (32,000 total) after the first flashing LED.

Maintenance service is chargeable.

Accessories

⚠ WARNING

The following tool accessories have been designed to function with the RP318 Press Tools. Other accessories suitable for use with other tools may create hazards when used on the RP318. To prevent serious injury, use only accessories specifically designed and recommended for use with the RP318, such as those listed below.

Ridge Tool Company provides standard pressing attachments designed specifically for use with RIDGID Standard Press Tools. Only use attachments that are specifically designed to press the fitting system you are installing. For a complete listing of RIDGID attachments available for this tool, see the Ridge Tool Catalog online at www.RIDGID.com.cn or call Ridge Tool Technical Services 400-820-5695.

RP318 Press Tool Accessories

Catalog No.	Description
56513	18V 2.5 Advanced Lithium Battery Pack
56518	18V 5.0 Advanced Lithium Battery Pack
64388	18V Advanced Lithium Charger
47133	Carrying Case (Plastic)
44823	China AC Power Adapter

Storage

Remove battery from tool and store tool and battery in case. Avoid storing the tool, batteries or charger in extreme heat or cold. The tool temperature sensor will not allow the tool to turn on if oil temperature is not within the temperature range of 15°F (-10°C) to 122°F (50°C). So it may be necessary to allow the tool to warm or cool to a temperature within the operating range by placing it in a

conditioned room before use. This will be indicated by two flashes and a pause continuously, of the LED light on the front of the tool.

⚠ WARNING Store the carrying case in a dry, secured, locked area that is out of reach of children and people unfamiliar with the RP318 Press Tool. The tool is dangerous in the hands of untrained users.

Service And Repair

⚠ WARNING

Improper service or repair can make machine unsafe to operate.

Service and repair on this RP318 Press Tool must be performed by a RIDGID Authorized Press Tool Service Center. The tool fasteners have been marked to indicate if service has been performed by unauthorized individuals.

For any repairs or maintenance, contact the Ridge Tool Company, Technical Service Department at 400-820-5695 or www.RIDGID.com.cn for nearest authorized press tool service outlet.

For information on your nearest RIDGID Authorized Press Tool Service Center or any service or repair questions:

- Contact your local RIDGID distributor.
- Visit www.RIDGID.com.cn to find your local RIDGID contact point.
- Call 400-820-5695.

Machine Disposal

Parts of this unit are valuable materials and can be recycled. There are companies that specialize in recycling that may be found locally.

Dispose of in compliance with any and all applicable regulations. Contact your local waste management authority for more information.

Troubleshooting

SYMPTOM	POSSIBLE REASONS	SOLUTION
Tool will not turn ON when switch is pressed.	Battery is completely discharged or battery has failed. Battery not properly inserted into handle of tool.	Insert fully charged battery/recharge battery. Check to assure battery is fully inserted.
Tool turns OFF either when switch is depressed or in the middle of a press cycle. The LED light will continuously flash ON and OFF.	Battery is discharged.	Insert fully charged battery/recharge battery.
The LED light flashes 2 times then pauses repeatedly. (The tool will not run when the switch is pressed.)	Tool or battery is too cold or too hot.	Bring tool and battery to correct operating range between 15°F (-10°C) to 122°F (50°C) by allowing the tool to sit in a conditioned room. NOTE! Connection must be repressed if tool stops in the middle of a press cycle. Failure to do so may result in a leaking fitting.
The LED light flashes 3 times then pauses repeatedly as long as tool is turned ON and tool functions properly.	Scheduled maintenance/recalibration is required after 30,000 presses.	Contact RIDGID Technical Service Department at 400-820-5695 for nearest Authorized Press Tool Service center.
The LED light flashes 3 times then pauses repeatedly, and tool will not begin press cycle when switch is depressed.	Scheduled maintenance/recalibration is mandatory after 32,000 presses, or tool malfunction detected. Tool is "locked" and will not function until tool is serviced.	Contact RIDGID Technical Service Department at 400-820-5695 for nearest Authorized Press Tool Service center.
Jaws are locked onto fitting.	Press was not successfully completed. Used wrong jaws for the tube size or material.	Push pressure release valve to remove jaws from fitting. Inspect and repress fitting. Install the correct jaws.
The pressed connections produced are not complete.	The tool was not square to the tube. Jaw contour was not aligned with the fitting contour.	Redo the joint with new fitting and new tube. Make sure that the tool is square to the tube. Redo the joint with new tube and new fitting. Make sure the jaw contour is aligned with the fitting contour.
	Tool is in need of repair.	Contact RIDGID Technical Service Department at 400-820-5695 for nearest Authorized Press Tool Service center.

RP318 Diagnostic Codes









Icon	Description	Meaning	Icon
	Solidly Lit.	Machine ON.	
	Continuous ON/OFF flashing.	Recharge battery.	
	2 flashes and a pause, repeating.	Out of temperature range, 15°F (-10°C) to 122°F (50°C).	
	3 flashes and a pause, repeating.	Service indicator after 30,000 cycles or tool malfunction. NOTE: Tool will lock after 32,000 cycles.	

Figure 10 – LED Light Diagnostic Codes

RIDGID® Tool Warranty

What Is Covered

RIDGID® tools are warranted to be free of defects in workmanship and material. Warranty coverage ends when the product becomes unusable for reasons other than defects in workmanship or material.

How Long The Coverage Lasts

Emerson Professional Tools (Shanghai) Co., Ltd. provides the following limited warranty for its power hydraulic pressing tool purchased in mainland China:

- 1 year warranty for power hydraulic pressing tool (RP318).
- The warranty period of the above product is calculated upon the date of purchase (based on the original valid invoice issued by dealer).

What Is Not Covered

Failures due to misuse, abuse, abnormal environment, improper operation conditions, use of non-original attachments, parts or components, as well as consumable parts (such as blade, die head, hydraulic seal, hydraulic oil and rechargeable battery) are not covered by this warranty. Emerson Professional Tools (Shanghai) Co., Ltd. shall not be responsible for any loss caused by reasons other than product defects.

Repair Service

Customers are entitled to the following repair service after professional evaluation by Emerson Professional Tools (Shanghai) Co., Ltd.:

- Free repair for products with defects in workmanship and material during warranty period; if after three attempts to repair during the warranty period the product is still defective, you can choose to replace the product or select a product in the same category (if there is a price difference of product in the same category, the balance will be paid).
- Paid repair for products with issues other than defects in workmanship and material.
- Paid repair for products out of warranty period.

How To Obtain Service

To obtain the benefit of this warranty, deliver the complete product at your own cost to our local agent or service center approved by us, original invoice of your product shall be presented for check (excluding products need paid repair service).

How Local Laws Relate To The Warranty

Customers are protected by the relevant laws in mainland China.

No Other Express Warranty Applies

In addition to this warranty, no employee, agent, dealer, or other person is authorized to alter this warranty or make any other warranty on behalf of Emerson Professional Tools (Shanghai) Co., Ltd.

Emerson Professional Tools (Shanghai) Co., Ltd. has the right for final explanation of the above warranty terms.